



PRODUCT CATALOG  
2014-2015

LEAVE  
LIMITS  
BEHIND

## Introduction

About ADIN .....	3
Dental Implant Systems .....	5
Surface Treatments .....	6

## Internal Conical Connection Implant Systems

Touareg CloseFit™ Implant Systems .....	8-9
---	-----

### Touareg CloseFit™ NP

NP Implant Systems .....	10
NP Prosthetic & Tools.....	11-14

### Touareg CloseFit™ RP

RP Implant System .....	15
RP Prosthetic & Tools.....	16-19

### Touareg CloseFit™ WP

WP Implant System .....	20-21
WP Prosthetic & Tools .....	22-25

## Standard Internal Hex Connection Implant Systems

Touareg™-OS & Touareg™-S Implant Systems .....	26-27
Touareg™-OS .....	28-32
Touareg™-S .....	33-37
Swell™.....	38-43
Standard Internal Hex Prosthetic & Tools .....	44-49

## One Piece Implant System

One™ .....	50-55
------------	-------

## Surgical Kits & Tools

Touareg CloseFit™ Surgical Kit .....	56-57
Touareg™ RS- Standart Internal Hex Surgical Kit .....	58-59
Prosthetic Kit .....	60
DLC Surgical Drills .....	61
Tools .....	62-63

## Index

In Alphabetical Order .....	65-69
In Numerical Order .....	69-73

ADIN Dental Implant Systems Ltd., designs, manufactures and markets state of the art, technologically advanced dental implant solutions. For more than 20 years, ADIN has provided dentists and dental technicians with innovative solutions and advanced knowledge into the field of implant dentistry. Located in northern Israel, The ADIN Group employs over 150 employees, each one playing a significant role in ADIN's growing success. ADIN highly values each hard working employee and attributes its growing success to their continuous dedication.

Over the years, ADIN has continuously focused on advancing its highly professional research and development team to ensure the production of technologically advanced, high quality products. ADIN works closely with the industry's leading dental professionals, surgeons and technicians, in both private and public sectors, along with dental schools in leading universities to provide customers with the most current, up-to-date industry knowledge and information.

ADIN prides itself on providing excellent customer service, constant customer communication and the availability to provide continuous excellent implantology solutions, from the simplest restorative case to the most complex surgical case.

ADIN's commitment to education today reflects on a better future and improving overall customer satisfaction. ADIN highly values continuous education, offering customers new research opportunities to explore and review new ideas in the field of Implantology.

Currently, ADIN is running a prospective multi-center study to validate the survival rates, bone remodeling and soft tissue maintenance of all dental implant systems.

With high quality implants, great customer service and a leading research and development team, ADIN is the perfect recipe for success.

LEAVE  
LIMITS  
BEHIND

Leading You  
to Success





### TOUAREG CloseFit™ Implant System

Conical Morse Taper Connection with OsseoFix™ - Calcium Phosphate Blasted Surface Treatment

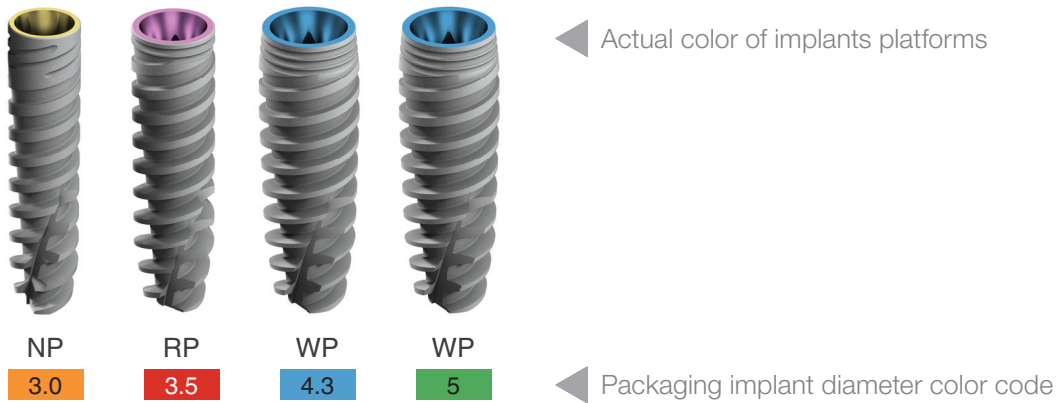

### Standard Internal Hex Implant Systems

#### TOUAREG™-OS

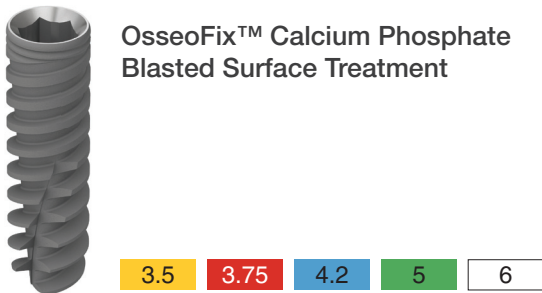

#### TOUAREG™-S

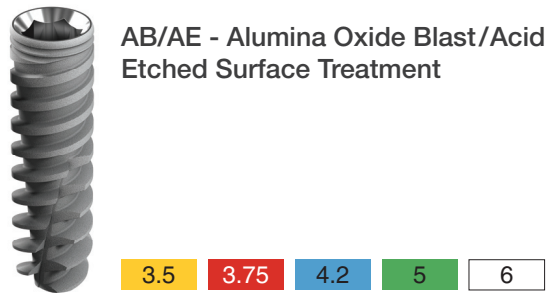

#### SWELL™

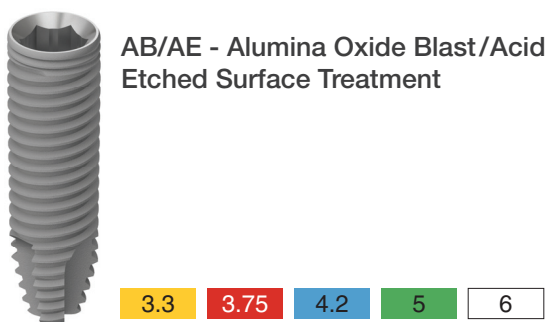

#### ONE™

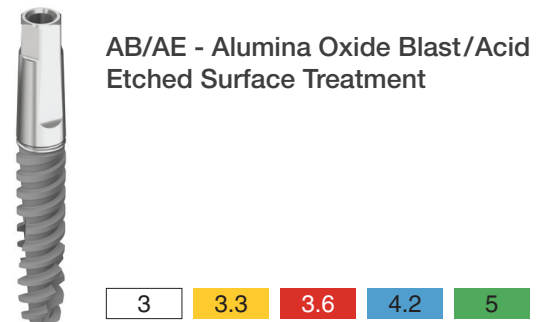

## OsseoFix™

Over the past 15 years, ADIN has followed several research studies conducted in order to discover the optimal implant surface treatment. Proper implant surface is needed to attain correct surface roughness and highest purity levels in order to achieve optimal osseointegration, increase the success rate of Bone to Implant Contact (BIC) and increase the healing process and tissue growth around the implant while eliminating the possibility of infections post-surgery.

ADIN has developed a highly successful implant surface treatment called OsseoFix™. OsseoFix™ is a pure titanium implant surface that uses calcium phosphate, a biocompatible resorbable blast media (RBM) that is debris free and has proven to achieve the desired roughness levels needed for optimal osseointegration and attain highest implant surface purity levels. The chemical composition of the OsseoFix™ surface is enriched with calcium, phosphorus and oxygen. The OsseoFix™ surface treatment is biocompatible and osseoconductive.

### OsseoFix™ surface treatment advantages:

- Biocompatible resorbable material creates a pure and clean surface texture
- Accelerates the healing process
- Increases optimal osseointegration
- Increases long term success

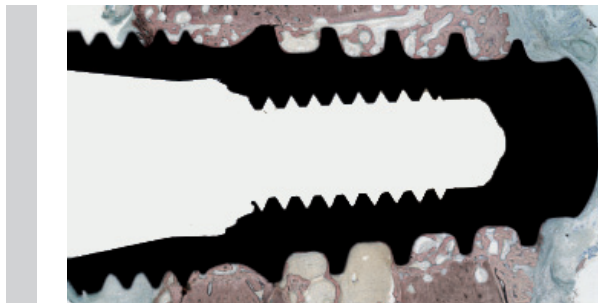
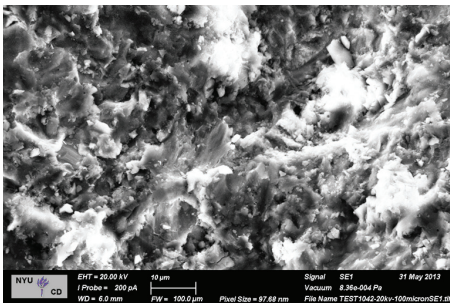

## AB/AE (SLA™\*) - Alumina oxide Blasted large grit followed by Acid Etch

AB/AE surface treatment involves blasting with large grit aluminum oxide particles followed by acid etching with sulfuric and hydrochloric acid to remove the embedded particles.

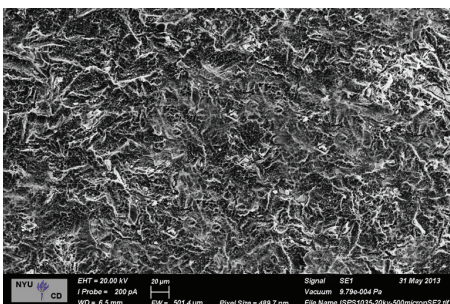

\* Institut Straumann AG's trademark

Cutting Edge Technology

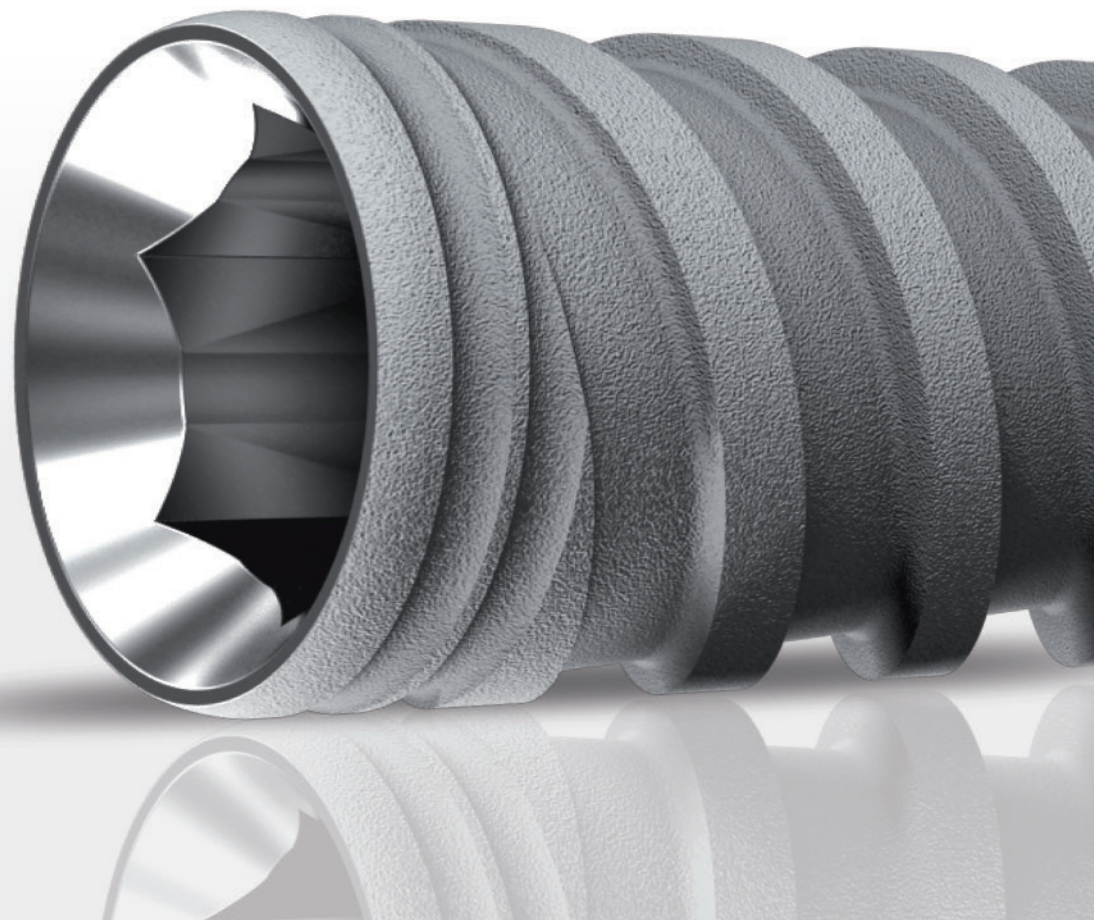

# 08

# TOUAREG CloseFit™ NP/RP/WP

## ADIN's Touareg CloseFit™ Conical Hex Morse taper Connection

The Touareg CloseFit™ spiral implant system offers a unique, strong and solid conical-hex connection. The conical-hex connection enables implants to be used in all indications and regions in the lower and upper jaw. The Morse Taper Connection minimizes micro movements between the implant and abutment.

The Touareg CloseFit™ spiral implant system is comprised of a tapered core implants with a spiral tap, promoting increased immediate stability. With their unique tip and double lead thread design (2x1.2mm), these implants slice through bone unlike conventional self-tapping implants, which scrape the bone away as they tap.

By repositioning bone as it is being inserted, Touareg CloseFit™ implants can be placed at different angles for exceptional primary stability and optimal restorative orientation, along with improved esthetics and a better loading distribution.

All Touareg CloseFit™ implants feature the OsseoFix™ surface treatment proven to achieve the desired roughness levels needed for optimal osseointegration, increase the success rate of Bone to Implant Contact (BIC) and attain the highest implant surface purity levels.

	L-8mm	L-10mm	L-11.5mm	L-13mm	L-15mm	L-16mm	L-18mm
NP-3.0mmD		ISPNP1030	ISPNP1130	ISPNP1330		ISPNP1630	ISPNP1830
RP-3.5mmD	ISPX0835	ISPX1035	ISPX1135	ISPX1335	ISPX1535		ISPX1835
WP-4.3mmD	ISPX0843	ISPX1043	ISPX1143	ISPX1343	ISPX1543		ISPX1843
WP-5.0mmD	ISPX0849	ISPX1049	ISPX1149	ISPX1349	ISPX1549		ISPX1849



**Touareg CloseFit™ Advantages:**

- OsseoFix™ Surface Treatment
- High primary stability, even in Type IV bone
- Self-tapping
- Double lead threads (2 x 1.2mm)
- Redirecting capability for more accurate implant placement
- Built-in platform switching and a strong CloseFit™ connection
- Requires minimally invasive surgery
- Immediate function / loading capability in all bone types

**TOUAREG™-WP** ▶

4.3 / 5.0mmD  
Wide Platform  
for wide / large  
ridges and spaces

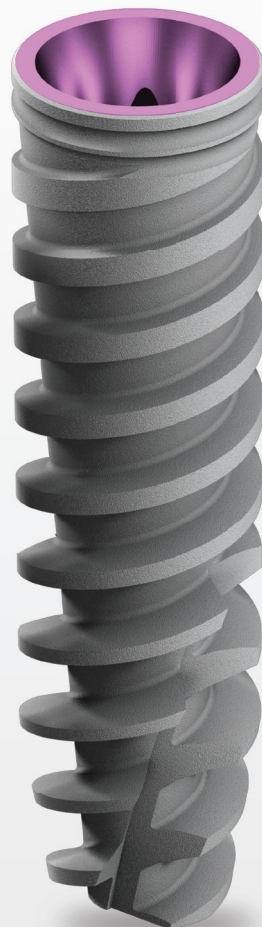
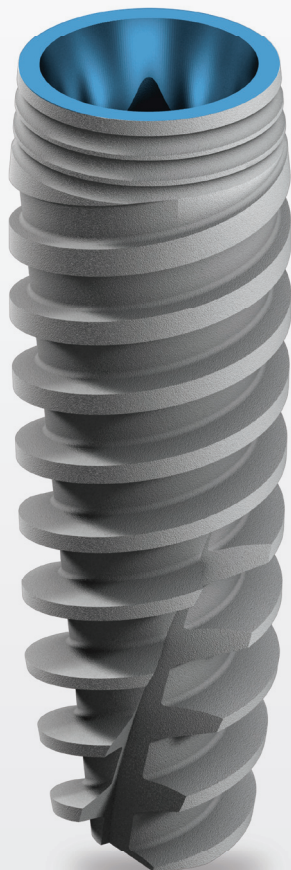
**TOUAREG™-RP** ◀

3.5mmD  
Regular Platform  
for standard size  
ridges and spaces

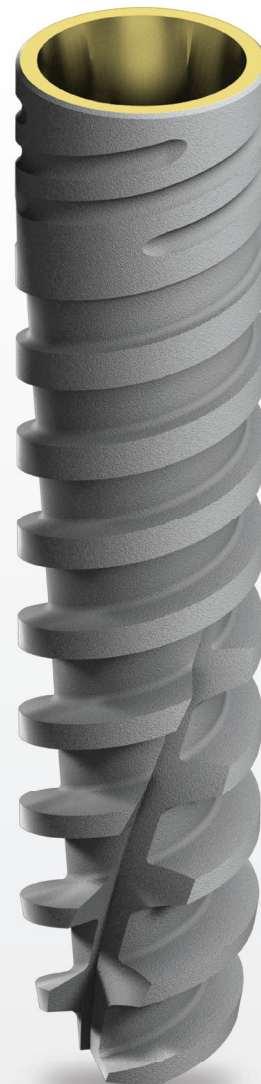
**TOUAREG™-NP** ◀

3.0mmD  
Narrow Platform for  
narrow ridges  
and tight spaces

## TOUAREG CloseFit™ - NP $\varnothing 3.0$

OsseoFix™ Surface  
Titanium Grade 5

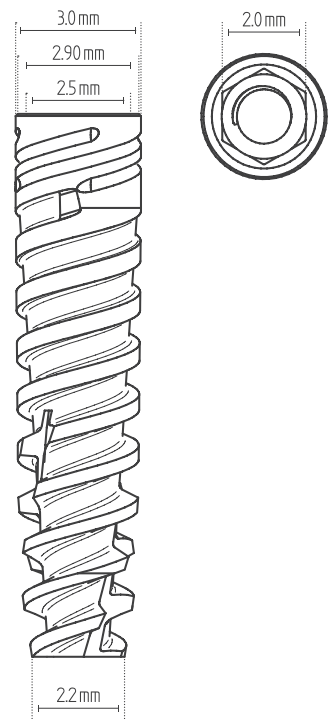
Catalog No.	Length mm		
ISPNP1030	10		
ISPNP1130	11.5		
ISPNP1330	13		
ISPNP1630	16		
ISPNP1830	18		

### Drill Sequence







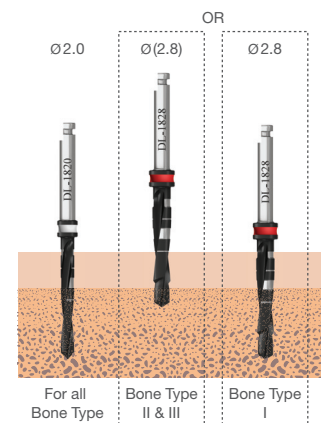



BONE TYPE D-IV	BONE TYPE D-II & III	BONE TYPE D-I
1. 2.0	1. 2.0 2. (2.8)	1. 2.0 2. 2.8

Note: (x.xx) drill to the depth of the cortex only. All measurements are in mm.

⚠ CAUTION: The drill preparation is up to 1mm longer than the implants.





### Healing Abutments

	NP0046	NP Slim Healing Abutment 3mmD x 2mmL	Ti Grade 5
	NP0047	NP Slim Healing Abutment 3mmD x 3mmL	Ti Grade 5
	NP0048	NP Slim Healing Abutment 3mmD X 4mmL	Ti Grade 5
	NP0049	NP Slim Healing Abutment 3mmD X 5mmL	Ti Grade 5
	NP0050	NP Slim Healing Abutment 3mmD X 6mmL	Ti Grade 5
	NP0004	NP Healing Abutment 4.5mmD X 2mmL	Ti Grade 5
	NP0008	NP Healing Abutment 4.5mmD X 3mmL	Ti Grade 5
	NP0009	NP Healing Abutment 4.5mmD X 4mmL	Ti Grade 5
	NP0012	NP Healing Abutment 4.5mmD X 5mmL	Ti Grade 5
	NP0013	NP Healing Abutment 4.5mmD X 6mmL	Ti Grade 5
	NP0090	NP Conical Healing Abutment 4.5mmD x 2mmL	Ti Grade 5
	NP0091	NP Conical Healing Abutment 4.5mmD x 3mmL	Ti Grade 5
	NP0092	NP Conical Healing Abutment 4.5mmD x 4mmL	Ti Grade 5
	NP0093	NP Conical Healing Abutment 4.5mmD x 5mmL	Ti Grade 5
	NP0094	NP Conical Healing Abutment 4.5mmD x 6mmL	Ti Grade 5



### Cement Retained

	NP0010	NP Straight Slim Abutment - No End Line	Ti Grade 5
	NP0019	NP Straight Abutment 1mm	Ti Grade 5
	NP0011	NP Straight Abutment 2mm	Ti Grade 5
	NP0064	NP Straight Abutment 3mm	Ti Grade 5
	NP0015	NP CloseFit™ Angled Abutment 15° 1mm	Ti Grade 5
	NP0026	NP CloseFit™ Angled Abutment 15° 2mm	Ti Grade 5
	NP0063	NP CloseFit™ Angled Abutment 15° 3mm	Ti Grade 5
	NP0018	NP CloseFit™ Angled Abutment 15° - No End Line	Ti Grade 5
	NP0043	NP Engaging Temporary Abutment	Ti Grade 5
	NP0044	NP Non Engaging Temporary Abutment	Ti Grade 5
	NP0045	NP Plastic Cylinder Abutment	Plastic

### Cement Retained

	NP3095	NP Engaging Titanium / Plastic Abutment	Ti Grade 5 / Plastic
	NP3097	NP Non Engaging Titanium / Plastic Abutment	Ti Grade 5 / Plastic

### Cement Retained - Zirconium Abutments

	ZA0105	NP Straight Zirconium Abutment w / Titanium Base	Zirconium / Ti Grade 5
	ZA0107	NP Angled Zirconium Abutment 15° w / Titanium Base	Zirconium / Ti Grade 5

### Screw Retained - MU Trans Mucosal Abutments (TMA™)





	NP0032	NP Straight Trans Mucosal Abutment 1mm	Ti Grade 5
	NP0033	NP Straight Trans Mucosal Abutment 2mm	Ti Grade 5
	NP0034	NP Straight Trans Mucosal Abutment 3mm	Ti Grade 5
	NP3729	NP Straight Trans Mucosal Abutment 4mm	Ti Grade 5
	NP3730	NP Straight Trans Mucosal Abutment 5mm	Ti Grade 5
	NP0035	NP Angled Trans Mucosal Abutment 17° 3mmL	Ti Grade 5
	NP0038	NP Angled Trans Mucosal Abutment 17° 4mmL	Ti Grade 5
	NP0036	NP Angled Trans Mucosal Abutment 30° 3.5mmL	Ti Grade 5
	NP0037	NP Angled Trans Mucosal Abutment 30° 5mmL	Ti Grade 5
	RS5005	TMA Healing Cap	Ti Grade 5
	RS4900	TMA Titanium Temporary Copying	Ti Grade 5
	RS5001	TMA Plastic Casting Sleeve w / Prosthetic Screw	Plastic
	RS5004	TMA Abutment Replica	Stainless Steel
	RS5006	TMA Impression Coping Open Tray	Ti Grade 5
	RS5011	TMA Closed Tray Transfer	Ti Grade 5

### Flat Connection

	NP0030	NP Flat Connection Abutment 2mm	Ti Grade 5
	NP0031	NP Flat Connection Abutment 4mm	Ti Grade 5
	FC5515	Flat Connection Temporary Cylinder Sleeve	Ti Grade 5
	FC5737	Flat Connection Implant Replica	Stainless Steel
	FC6011	Flat Connection Castable Abutment for Centering Ring	Plastic







### Flat Connection

	FC6015	Flat Connection Titanium Retaining Screw	Ti Grade 5
	FC6013	Flat Connection Titanium Gluing Ring	Ti Grade 5
	FC6017	Flat Connection Long Laboratory Screw	Ti Grade 5
	FC6018	Flat Connection Centring Ring	Ti Grade 5
	FC5512	Flat Connection Transfer Impression Coping	Stainless Steel

### Ball Attachment - Overdentures

	NP0020	NP Ball Attachment 0.5mm	Ti Grade 5
	NP0021	NP Ball Attachment 1mm	Ti Grade 5
	NP0022	NP Ball Attachment 2mm	Ti Grade 5
	NP0023	NP Ball Attachment 3mm	Ti Grade 5
	NP0024	NP Ball Attachment 4mm	Ti Grade 5
	RS2660	Plastic Ball Cap White	Nylon
	RS2662	Plastic Ball Cap Pink Soft	Nylon
	RS2670	Titanium Ball Cap	Ti Grade 5
	RS2675SS	Stainless steel Ball Cap	Stainless Steel

### Prosthetic Hand Drivers

	RP0064	Star Hand Driver - Short	Stainless Steel
	RP0004	Star Hand Driver - Long	Stainless Steel
	RS6193	TMA/FC Female Hand Hex Driver - Short	Stainless Steel
	RS6191	TMA/FC Female Hand Hex Driver - Long	Stainless Steel



### Torque Drivers

	NP0006	NP 2mm Torque Driver - Short	Stainless Steel
	NP0005	NP 2mm Torque Driver - Long	Stainless Steel
	RP0065	Star Torque Driver - Short	Stainless Steel
	RP0005	Star Torque Driver - Long	Stainless Steel
	RS6090	Torque Driver for Ball Attachment	Stainless Steel
	RS6197	TMA/FC Hex Torque Driver - Short	Stainless Steel
	RS6196	TMA/FC Hex Torque Driver - Long	Stainless Steel



## Handpiece Drivers and Adaptors

	NP0062	NP 2mm Hex Handpiece Adapter - Short	Stainless Steel
	NP0072	NP 2mm Hex Handpiece Adapter - Long	Stainless Steel
	RP0018	Star Handpiece Driver - Short	Stainless Steel
	RP0019	Star Handpiece Driver - Long	Stainless Steel
	RS6194	TMA/ FC Hex Handpiece Adapter - Short	Stainless Steel
	RS6195A	TMA / FC Hex Handpiece Adapter - Long	Stainless Steel

## Analog

	NP0007	NP Implant Analog	Stainless Steel
	RS5740	Ball Attachment Abutment Replica	Stainless Steel











## Transfers (Implant level)

	NP0016	NP Slim Closed Tray Transfer	Stainless Steel
	NP0017	NP Open Tray Transfer	Stainless Steel

## NP Retrieval Screw

	NP0014	NP Retrieval Screw for Abutments	Ti Grade 5
---	--------	----------------------------------	------------

## NP Screws

	NP0002	NP Implant Cover Screw	Ti Grade 5
	NP0001	NP Abutment Screw	Ti Grade 5
	NP0027	NP Closed Tray Transfer Screw	Ti Grade 5
	NP0028	NP Open Tray Transfer Screw	Ti Grade 5
	NP0039	NP Retaining Screw for TMA 1mm	Ti Grade 5
	NP0040	NP Retaining Screw for TMA 2mm	Ti Grade 5
	NP0041	NP Retaining Screw for TMA 3mm	Ti Grade 5
	NP3409	NP Retaining Screw for TMA 4mm	Ti Grade 5
	NP3412	NP Retaining Screw for TMA 5mm	Ti Grade 5
	NP0042	NP Retaining Screw for Angled TMA	Ti Grade 5
	ZA0101	NP Screw For Zirconia Abutment	Ti Grade 5

**TOUAREG CloseFit™ - RP** **Ø3.5**

OsseoFix™ Surface  
Titanium Grade 5

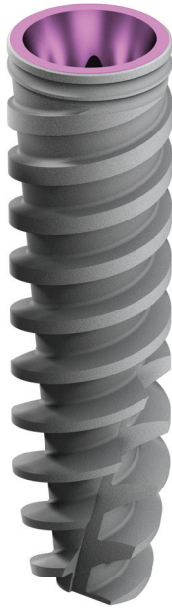
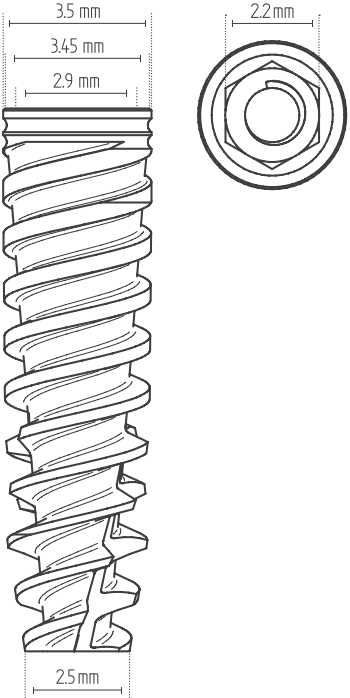
Catalog No.	Length mm		
ISPX0835	8		
ISPX1035	10		
ISPX1135	11.5		
ISPX1335	13		
ISPX1535	15		
ISPX1835	18		

**Drill Sequence**

BONE TYPE D-IV	BONE TYPE D-II & III	BONE TYPE D-I
1. Tri-Step*	1. Tri-Step* 2. (3.2)	1. Tri-Step* 2. (3.2)

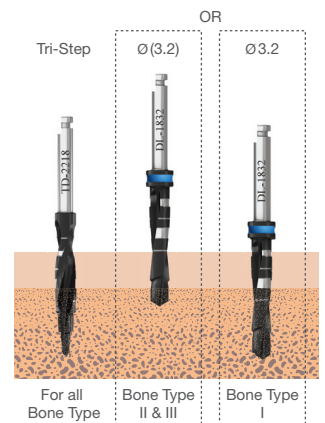















Note: (x.xx) drill to the depth of the cortex only. All measurements are in mm.

⚠ CAUTION: The drill preparation is up to 1mm longer than the implants.

\* For initial drilling, you may use 2, 2.8 and 3.2 drills in sequence instead of the Tri-Step drill.



### Healing Abutments

	RP0046	RP Slim Healing Abutment 3.5mmD x 2mmL	Ti Grade 5
	RP0047	RP Slim Healing Abutment 3.5mmD x 3mmL	Ti Grade 5
	RP0048	RP Slim Healing Abutment 3.5mmD x 4mmL	Ti Grade 5
	RP0049	RP Slim Healing Abutment 3.5mmD x 5mmL	Ti Grade 5
	RP0050	RP Slim Healing Abutment 3.5mmD x 6mmL	Ti Grade 5
	RP0022	RP Healing Abutment 4.5mmD x 2mmL	Ti Grade 5
	RP0023	RP Healing Abutment 4.5mmD x 3mmL	Ti Grade 5
	RP0024	RP Healing Abutment 4.5mmD x 4mmL	Ti Grade 5
	RP0025	RP Healing Abutment 4.5mmD x 5mmL	Ti Grade 5
	RP0026	RP Healing Abutment 4.5mmD x 6mmL	Ti Grade 5
	RP0090	RP Conical Healing Abutment 4.5mmD x 2mmL	Ti Grade 5
	RP0091	RP Conical Healing Abutment 4.5mmD x 3mmL	Ti Grade 5
	RP0092	RP Conical Healing Abutment 4.5mmD x 4mmL	Ti Grade 5
	RP0093	RP Conical Healing Abutment 4.5mmD x 5mmL	Ti Grade 5
	RP0094	RP Conical Healing Abutment 4.5mmD x 6mmL	Ti Grade 5













### Cement Retained

	RP0020	RP Straight Slim Abutment - No End Line	Ti Grade 5
	RP0012	RP Straight Abutment 1mm	Ti Grade 5
	RP0011	RP Straight Abutment 2mm	Ti Grade 5
	RP0010	RP Straight Abutment 3mm	Ti Grade 5
	RP0013	RP Angled Abutment 15° 1mm	Ti Grade 5
	RP0014	RP Angled Abutment 15° 2mm	Ti Grade 5
	RP0015	RP Angled Abutment 15° 3mm	Ti Grade 5
	RP0043	RP Engaging Temporary Abutment	Ti Grade 5
	RP0044	RP Non Engaging Temporary Abutment	Ti Grade 5
	RP0045	RP Plastic Cylinder Abutment	Plastic
	RP3095	RP Engaging Titanium / Plastic Abutment	Ti Grade 5 / Plastic
	RP3097	RP Non-Engaging Titanium / Plastic Abutment	Ti Grade 5 / Plastic

**Cement Retained - Zirconium Abutments**

	ZA0214	RP Straight Zirconium Abutment w / Titanium Base	Zirconium/Ti Grade 5
	ZA0207	RP Angled Zirconium Abutment 15° w / Titanium Base	Zirconium/Ti Grade 5

**Screw Retained - MU Trans Mucosal Abutments (TMA™)**

	RP0032	RP Straight Trans Mucosal Abutment 1mm	Ti Grade 5
	RP0033	RP Straight Trans Mucosal Abutment 2mm	Ti Grade 5
	RP0034	RP Straight Trans Mucosal Abutment 3mm	Ti Grade 5
	RP3729	RP Straight Trans Mucosal Abutment 4mm	Ti Grade 5
	RP3730	RP Straight Trans Mucosal Abutment 5mm	Ti Grade 5
	RP3734	RP Angled Trans Mucosal Abutment 17° 2.5mm	Ti Grade 5
	RP3737	RP Angled Trans Mucosal Abutment 17° 3.5mm	Ti Grade 5
	RP3735	RP Angled Trans Mucosal Abutment 30° 3mm	Ti Grade 5
	RP3738	RP Angled Trans Mucosal Abutment 30° 4mm	Ti Grade 5
	RS5005	TMA Healing Cap	Ti Grade 5
	RS4900	TMA Titanium Temporary Copying	Ti Grade 5
	RS5001	TMA Plastic Casting Sleeve w / Prosthetic Screw	Plastic
	RS5004	TMA Abutment Replica	Ti Grade 5
	RS5006	TMA Impression Coping Open Tray	Ti Grade 5
	RS5011	TMA Closed Tray Transfer	Ti Grade 5

**Flat Connection**

	RP0030	RP Flat Connection Abutment 2mm	Ti Grade 5
	RP0031	RP Flat Connection Abutment 4mm	Ti Grade 5
	FC5515	Flat Connection Temporary Cylinder Sleeve	Ti Grade 5
	FC5737	Flat Connection Implant Replica	Stainless Steel
	FC6011	Flat Connection Castable Abutment for Centring Ring	Plastic
	FC6015	Flat Connection Titanium Retaining Screw	Ti Grade 5
	FC6013	Flat Connection Titanium Gluing Ring	Ti Grade 5
	FC6017	Flat Connection Long Laboratory Screw	Ti Grade 5

## Flat Connection



FC6018

Flat Connection Centring Ring

Ti Grade 5



FC5512

Flat Connection Transfer Impression Coping

Stainless Steel

## Ball Attachment - Overdentures



RP0051

RP Ball Attachment 0.5mm

Ti Grade 5



RP0052

RP Ball Attachment 1mm

Ti Grade 5



RP0053

RP Ball Attachment 2mm

Ti Grade 5



RP0054

RP Ball Attachment 3mm

Ti Grade 5



RP0055

RP Ball Attachment 4mm

Ti Grade 5



RP0056

RP Ball Attachment 5mm

Ti Grade 5



RS2660

Plastic Ball Cap White

Nylon



RS2662

Plastic Ball Cap Pink Soft

Nylon



RS2670

Titanium Ball Cap

Ti Grade 5



RS2675SS

Stainless Steel Ball Cap

Stainless Steel

## Prosthetic Hand Drivers



RP0064

Star Hand Driver - Short

Stainless Steel



RP0004

Star Hand Driver - Long

Stainless Steel



RS6193

TMA/FC Female Hand Hex Driver - Short

Stainless Steel



RS6191

TMA/FC Female Hand Hex Driver - Long

Stainless Steel

## Torque Drivers



RP0065

Star Torque Driver - Short

Stainless Steel



RP0005

Star Torque Driver - Long

Stainless Steel



RP0067

RP 2.2mm Hex Torque Driver - Short

Stainless Steel



RP0066

RP 2.2mm Hex Torque Driver - Long

Stainless Steel



RS6197

TMA/FC Hex Torque Driver - Short

Stainless Steel



RS6196

TMA/FC Hex Torque Driver - Long

Stainless Steel



RS6090



Torque Driver for Ball Attachment

Stainless Steel



### Handpiece Drivers and Adaptors

	RP0018	Star Handpiece Driver - Short	Stainless Steel
	RP0019	Star Handpiece Driver - Long	Stainless Steel
	RP0062	RP Handpiece Hex Adapter - Short	Stainless Steel
	RP0072	RP Handpiece Hex Adapter - Long	Stainless Steel
	RS6194	TMA / FC Hex Handpiece Adapter - Short	Stainless Steel
	RS6195A	TMA / FC Hex Handpiece Adapter - Long	Stainless Steel

### Analogs

	RP0007	RP Implant Analog	Stainless Steel
	RS5740	Ball Attachment Abutment Replica	Stainless Steel

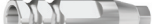

### Transfers (Implant level)

	RP0016	RP Slim Closed Tray Transfer	Stainless Steel
	RP0017	RP Open Tray Transfer	Stainless Steel

### RP Retrieval Screw

	RP3401	RP Retrieval Screw for Abutments	Ti Grade 5
---	--------	----------------------------------	------------

### RP Screws

	RP0021	RP Implant Cover Screw	Ti Grade 5
	RP0001	RP Abutment Screw	Ti Grade 5
	RP0027	RP Closed Tray Transfer Screw	Ti Grade 5
	RP0028	RP Open Tray Transfer Screw	Ti Grade 5
	RP0039	RP Retaining Screw for TMA 1mm	Ti Grade 5
	RP0040	RP Retaining Screw for TMA 2mm	Ti Grade 5
	RP0041	RP Retaining Screw for TMA 3mm	Ti Grade 5
	RP3409	RP Retaining Screw for TMA 4mm	Ti Grade 5
	RP3412	RP Retaining Screw for TMA 5mm	Ti Grade 5
	RP3403	RP Retaining Screw for Angled TMA	Ti Grade 5
	ZA0201	RP Screw For Zirconia Abutment	Ti Grade 5



## TOUAREG CloseFit™ - WP

Ø 4.3

OsseoFix™ Surface  
Titanium Grade 5

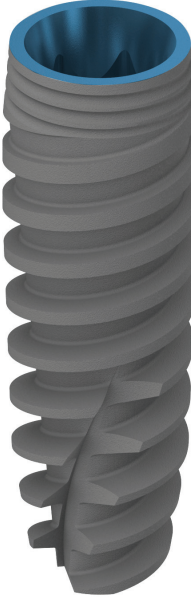
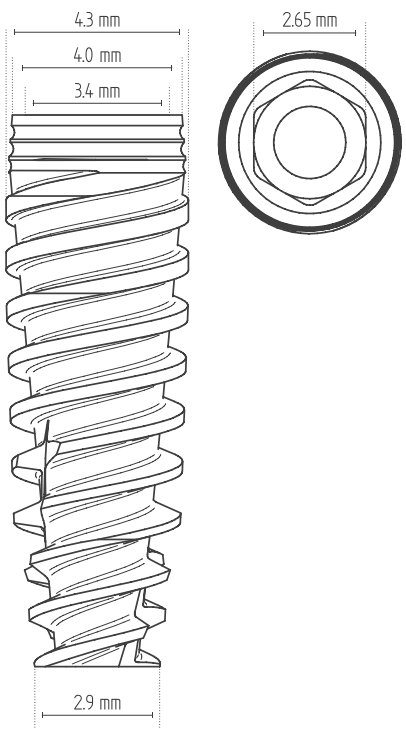
Catalog No.	Length mm		
ISPX0843	8		
ISPX1043	10		
ISPX1143	11.5		
ISPX1343	13		
ISPX1543	15		
ISPX1843	18		

### Drill Sequence

BONE TYPE D-IV	BONE TYPE D-II & III	BONE TYPE D-I
1. Tri-Step* 2. (3.6)	1. Tri-Step* 2. (3.6)	1. Tri-Step* 2. 3.6

Note: (x.xx) drill to the depth of the cortex only. All measurements are in mm.

⚠ CAUTION: The drill preparation is up to 1mm longer than the implants.

\* For initial drilling, you may use 2, 2.8 and 3.2 drills in sequence instead of the Tri-Step drill.

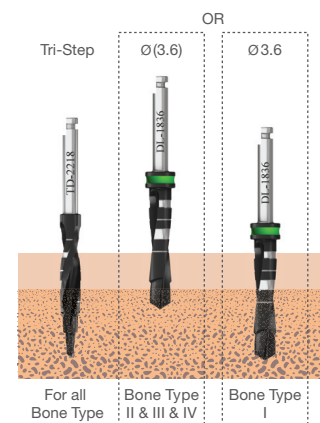



**TOUAREG CloseFit™ - WP** Ø5.0

OsseoFix™ Surface  
Titanium Grade 5

Catalog No.	Length mm	
ISPX0849	8	
ISPX1049	10	
ISPX1149	11.5	
ISPX1349	13	
ISPX1549	15	
ISPX1849	18	

**Drill Sequence**

BONE TYPE D-IV	BONE TYPE D-II & III	BONE TYPE D-I
1. Tri-Step*	1. Tri-Step*	1. Tri-Step*
2. 3.6	2. 3.6	2. 3.6
3. (4.2)	3. 4.2	3. 4.2
	4. (4.6)	4. 4.6

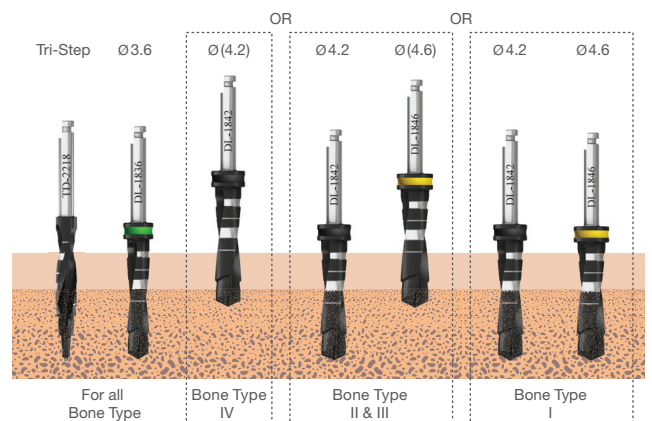

Note: (x.xx) drill to the depth of the cortex only.  
All measurements are in mm.

⚠ CAUTION: The drill preparation is up to 1mm longer than the implants.

\* For initial drilling, you may use 2, 2.8 and 3.2 drills in sequence instead of the Tri-Step drill.



### Healing Abutments

	WP0046	WP Slim Healing Abutment 4mmD x 2mmL	Ti Grade 5
	WP0047	WP Slim Healing Abutment 4mmD x 3mmL	Ti Grade 5
	WP0048	WP Slim Healing Abutment 4mmD X 4mmL	Ti Grade 5
	WP0049	WP Slim Healing Abutment 4mmD X 5mmL	Ti Grade 5
	WP0050	WP Slim Healing Abutment 4mmD X 6mmL	Ti Grade 5
	WP0022	WP Healing Abutment 5.5mmD X 2mmL	Ti Grade 5
	WP0023	WP Healing Abutment 5.5mmD X 3mmL	Ti Grade 5
	WP0024	WP Healing Abutment 5.5mmD X 4mmL	Ti Grade 5
	WP0025	WP Healing Abutment 5.5mmD X 5mmL	Ti Grade 5
	WP0026	WP Healing Abutment 5.5mmD X 6mmL	Ti Grade 5
	WP0090	WP Conical Healing Abutment 5.5mmD x 2mmL	Ti Grade 5
	WP0091	WP Conical Healing Abutment 5.5mmD x 3mmL	Ti Grade 5
	WP0092	WP Conical Healing Abutment 5.5mmD x 4mmL	Ti Grade 5
	WP0093	WP Conical Healing Abutment 5.5mmD x 5mmL	Ti Grade 5
	WP0094	WP Conical Healing Abutment 5.5mmD x 6mmL	Ti Grade 5















### Cement Retained

	WP0020	WP Straight Slim Abutment - No End Line	Ti Grade 5
	WP0012	WP Straight Abutment 1mm	Ti Grade 5
	WP0011	WP Straight Abutment 2mm	Ti Grade 5
	WP0010	WP Straight Abutment 3mm	Ti Grade 5
	WP0013	WP Angled Abutment 15° 1mm	Ti Grade 5
	WP0014	WP Angled Abutment 15° 2mm	Ti Grade 5
	WP0015	WP Angled Abutment 15° 3mm	Ti Grade 5
	WP0043	WP Engaging Temporary Abutment	Ti Grade 5
	WP0044	WP Non Engaging Temporary Abutment	Ti Grade 5
	WP0045	WP Plastic Cylinder Abutment	Plastic
	WP3095	WP Engaging Titanium / Plastic Abutment	Ti Grade 5 / Plastic
	WP3097	WP Non Engaging Titanium / Plastic Abutment	Ti Grade 5 / Plastic

### Cement Retained - Zirconium Abutments

	ZA0314	WP Straight Zirconium Abutment w / Titanium Base	Zirconium / Ti Grade 5
	ZA0307	WP Angled Zirconium Abutment 15° w / Titanium Base	Zirconium / Ti Grade 5



### Screw Retained - MU Trans Mucosal Abutments (TMA™)

	WP3731	WP Straight Trans Mucosal Abutment 1mm	Ti Grade 5
	WP3732	WP Straight Trans Mucosal Abutment 2mm	Ti Grade 5
	WP3733	WP Straight Trans Mucosal Abutment 3mm	Ti Grade 5
	WP3729	WP Straight Trans Mucosal Abutment 4mm	Ti Grade 5
	WP3730	WP Straight Trans Mucosal Abutment 5mm	Ti Grade 5
	WP3734	WP Angled Trans Mucosal Abutment 17° 2.5mm	Ti Grade 5
	WP3737	WP Angled Trans Mucosal Abutment 17° 3.5mm	Ti Grade 5
	WP3735	WP Angled Trans Mucosal Abutment 30° 3mm	Ti Grade 5
	WP3738	WP Angled Trans Mucosal Abutment 30° 4mm	Ti Grade 5
	RS5005	TMA Healing Cap	Ti Grade 5
	RS4900	TMA Titanium Temporary Copying	Ti Grade 5
	RS5001	TMA Plastic Casting Sleeve w/Prosthetic Screw	Plastic
	RS5004	TMA Abutment Replica	Ti Grade 5
	RS5006	TMA Impression Coping Open Tray	Ti Grade 5
	RS5011	TMA Closed Tray Transfer	Ti Grade 5

### Flat Connection

	WP0030	WP Flat Connection Abutment 2mm	Ti Grade 5
	WP0031	WP Flat Connection Abutment 4mm	Ti Grade 5
	FC5515	Flat Connection Temporary Cylinder Sleeve	Ti Grade 5
	FC5737	Flat Connection Implant Replica	Ti Grade 5
	FC6011	Flat Connection Castable Abutment for Centring Ring	Plastic
	FC6015	Flat Connection Titanium Retaining Screw	Ti Grade 5
	FC6013	Flat Connection Titanium Gluing Ring	Ti Grade 5

### Flat Connection

	FC6017	Flat Connection Long Laboratory Screw	Ti Grade 5
	FC6018	Flat Connection Centring Ring	Ti Grade 5
	FC5512	Flat Connection Transfer Impression Coping	Ti Grade 5

### Ball Attachment - Overdentures

	WP0051	WP Ball Attachment 0.5mm	Ti Grade 5
	WP0052	WP Ball Attachment 1mm	Ti Grade 5
	WP0053	WP Ball Attachment 2mm	Ti Grade 5
	WP0054	WP Ball Attachment 3mm	Ti Grade 5
	WP0055	WP Ball Attachment 4mm	Ti Grade 5
	WP0056	WP Ball Attachment 5mm	Ti Grade 5
	RS2660	Plastic Ball Cap White	Nylon
	RS2662	Plastic Ball Cap Pink Soft	Nylon
	RS2670	Titanium Ball Cap	Ti Grade 5
	RS2675SS	Stainless Steel Ball Cap	Stainless Steel

### Prosthetic Hand Drivers

	RP0064	Star Hand Driver - Short	Stainless Steel
	RP0004	Star Hand Driver - Long	Stainless Steel
	RS6193	TMA / FC Female Hand Hex Driver - Short	Stainless Steel
	RS6191	TMA / FC Female Hand Hex Driver - Long	Stainless Steel



### Torque Drivers

	WP0067	WP 2.6mm Torque Driver - Short	Stainless Steel
	WP0066	WP 2.6mm Torque Driver - Long	Stainless Steel
	RP0065	Star Torque Driver - Short	Stainless Steel
	RP0005	Star Torque Driver - Long	Stainless Steel
	RS6197	TMA / FC Hex Torque Driver - Short	Stainless Steel
	RS6196	TMA / FC Hex Torque Driver - Long	Stainless Steel
	RS6090	Torque Driver for Ball Attachment	Stainless Steel



### Handpiece Drivers and Adaptors

	RP0018	Star Handpiece Driver - Short	Stainless Steel
	RP0019	Star Handpiece Driver - Long	Stainless Steel
	WP0062	WP Handpiece Hex Adapter - Short	Stainless Steel
	WP0072	WP Handpiece Hex Adapter - Long	Stainless Steel
	RS6194	TMA/FC Hex Handpiece Adapter - Short	Stainless Steel
	RS6195A	TMA/FC Hex Handpiece Adapter - Long	Stainless Steel

### Analogs

	WP0007	WP Implant Analog	Stainless Steel
	RS5740	Ball Attachment Abutment Replica	Stainless Steel











### Transfers (Implant level)

	WP0016	WP Slim Closed Tray Transfer	Stainless Steel
	WP0017	WP Open Tray Transfer	Stainless Steel

### WP Retrieval Screw

	WP3401	WP Retrieval Screw for Abutments	Ti Grade 5
---	--------	----------------------------------	------------

### WP Screws

	WP0021	WP Implant Cover Screw	Ti Grade 5
	WP0001	WP Abutment Screw	Ti Grade 5
	WP0027	WP Closed Tray Transfer Screw	Ti Grade 5
	WP0028	WP Open Tray Transfer Screw	Ti Grade 5
	WP3406	WP Retaining Screw for TMA 1mm	Ti Grade 5
	WP3407	WP Retaining Screw for TMA 2mm	Ti Grade 5
	WP3408	WP Retaining Screw for TMA 3mm	Ti Grade 5
	WP3409	WP Retaining Screw for TMA 4mm	Ti Grade 5
	WP3412	WP Retaining Screw for TMA 5mm	Ti Grade 5
	WP3403	WP Retaining Screw for Angled TMA	Ti Grade 5
	ZA0301	WP Screw for Zirconia Abutment	Ti Grade 5

# 26

# TOUAREG™ OS/S

## Standard Internal Hex Touareg™-OS, Touareg™-S

The Touareg™-OS, and Touareg™-S spiral implants are tapered implants with a spiral tap that condenses bone during placement for enhanced immediate stability. They have two large variable threads and a tapered core for accurate implant placement, self-tapping, improved esthetics and better load distribution.

The Touareg™-OS and Touareg™-S implants both feature a special round shaped apex that pushes the bone graft with minimal harm to anatomic structures. The Touareg™-S and Touareg™-OS implants are very user-friendly and their unique design often allows for immediate function for all bone types.

The Touareg™-S features a standard SLAT™\* - AB/AE- Alumina Oxide Blasted / Acid Etched surface treatment.

The Touareg™-OS features ADIN's unique OsseoFix™-Calcium Phosphate blast surface treatment.

\* Institut Straumann AG's trademark

### TOUAREG™-OS

	L-6.25mm	L-8mm	L-10mm	L-11.5mm	L-13mm	L-16mm	L-18mm
ISF-3.5mmD		ISF0835	ISF1035	ISF1135	ISF1335	ISF1635	ISF1835
ISF-3.75mmD		ISF0838	ISF1038	ISF1138	ISF1338	ISF1638	ISF1838
ISF-4.2mmD	ISF0642	ISF0842	ISF1042	ISF1142	ISF1342	ISF1642	ISF1842
ISF-5.0mmD	ISF0650	ISF0850	ISF1050	ISF1150	ISF1350	ISF1650	
ISF-6.0mmD	ISF0660	ISF0860	ISF1060	ISF1160	ISF1360		

### TOUAREG™-S

	L-6.25mm	L-8mm	L-10mm	L-11.5mm	L-13mm	L-16mm	L-18mm
ISPS-3.5mmD		ISPS 0835	ISPS1035	ISPS1135	ISPS1335	ISPS1635	ISPS1835
ISPS-3.75mmD		ISPS0838	ISPS1038	ISPS1138	ISPS1338	ISPS1638	ISPS1838
ISPS-4.2mmD	ISPS0642	ISPS0842	ISPS1042	ISPS1142	ISPS1342	ISPS1642	ISPS1842
ISPS-5.0mmD	ISPS0650	ISPS0850	ISPS1050	ISPS1150	ISPS1350	ISPS1650	
ISPS-6.0mmD	ISPS0660	ISPS0860	ISPS1060	ISPS1160	ISPS1360		



**Touareg™ - OS and Touareg™ - S Advantages:**

- Double lead threads (2x1.2mm)
- High primary stability, also in Type IV bone
- Bone-condensing property
- Self-tapping
- Redirecting capability for optimal placement
- Built-in platform switching
- Minimally invasive surgery
- Immediate function / loading capability
- Single restorative / prosthetic platform for easy restoration

▼ **TOUAREG™ - OS**  
OsseoFix™ surface treatment

**TOUAREG™ - S** ►  
AB/AE surface treatment

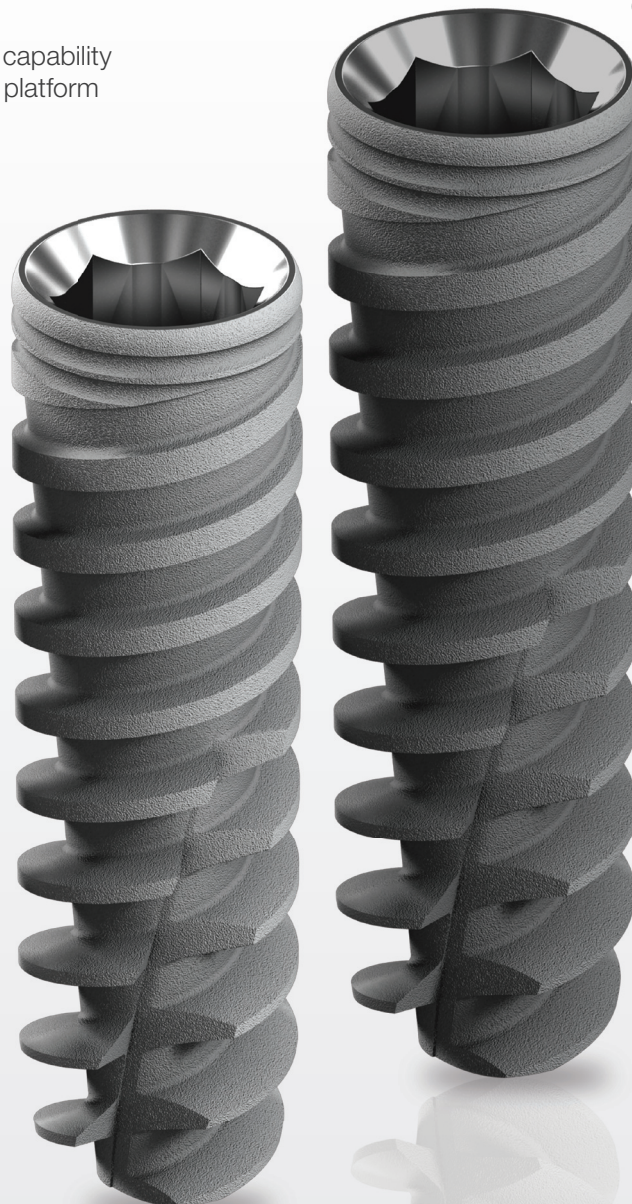

## TOUAREG™ - OS $\varnothing 3.5$

OsseoFix™ Surface  
Titanium Grade 5

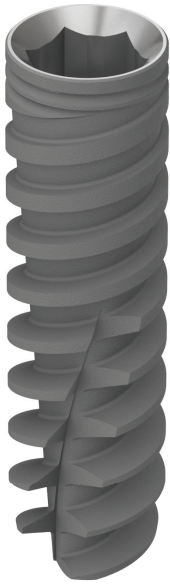
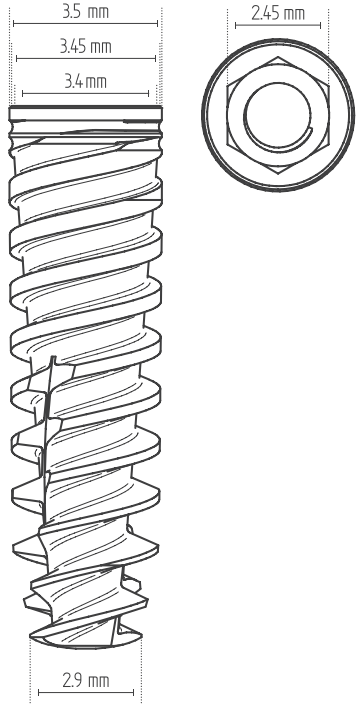
Catalog No.	Length mm		
ISF0835	8		
ISF1035	10		
ISF1135	11.5		
ISF1335	13		
ISF1635	16		
ISF1835	18		

### Drill Sequence

BONE TYPE D-IV	BONE TYPE D-II & III	BONE TYPE D-I
1. Tri-Step*	1. Tri-Step* 2. (3.2)	1. Tri-Step* 2. (3.2)

Note: (x.xx) drill to the depth of the cortex only. All measurements are in mm.

⚠ CAUTION: The drill preparation is up to 1mm longer than the implants.

\* For initial drilling, you may use 2, 2.8 and 3.2 drills in sequence instead of the Tri-Step drill.

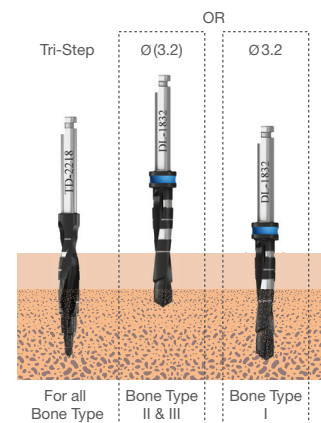



**TOUAREG™ - OS**    **Ø3.75**

OsseoFix™ Surface  
Titanium Grade 5

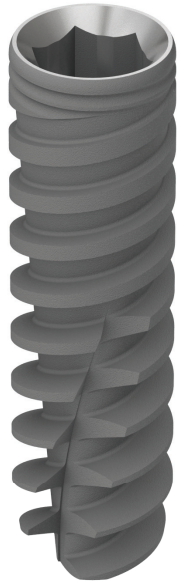
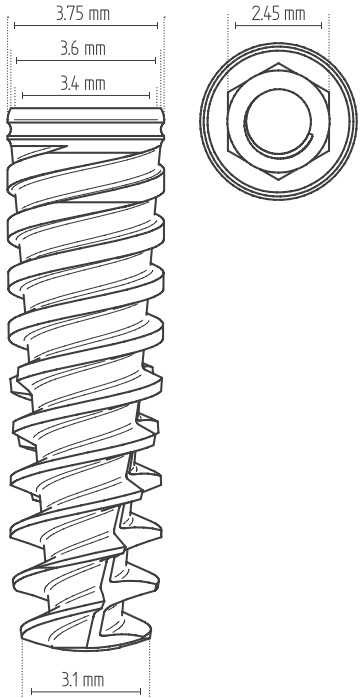
Catalog No.	Length mm		
ISF0838	8		
ISF1038	10		
ISF1138	11.5		
ISF1338	13		
ISF1638	16		
ISF1838	18		

**Drill Sequence**

BONE TYPE D-IV	BONE TYPE D-II & III	BONE TYPE D-I
1. Tri-Step*	1. Tri-Step* 2. (3.2)	1. Tri-Step* 2. 3.2

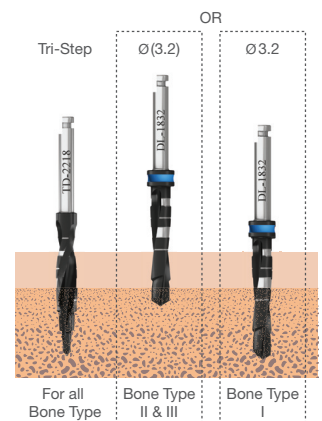

Note: (x.xx) drill to the depth of the cortex only. All measurements are in mm.

⚠ CAUTION: The drill preparation is up to 1mm longer than the implants.

\* For initial drilling, you may use 2, 2.8 and 3.2 drills in sequence instead of the Tri-Step drill.

## TOUAREG™ - OS Ø4.2

OsseoFix™ Surface  
Titanium Grade 5

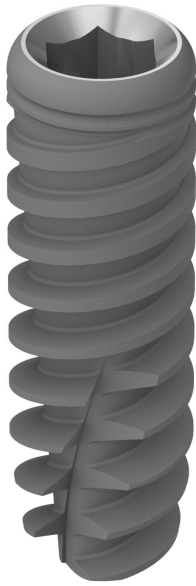
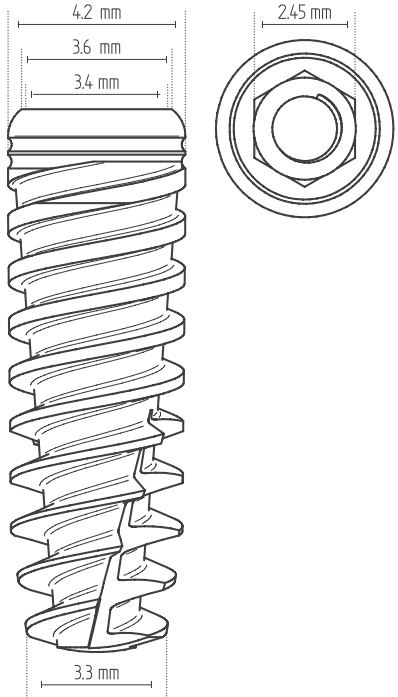
Catalog No.	Length mm		
ISF0642	6.25		
ISF0842	8		
ISF1042	10		
ISF1142	11.5		
ISF1342	13		
ISF1642	16		
ISF1842	18		

### Drill Sequence

BONE TYPE D-IV	BONE TYPE D-II & III	BONE TYPE D-I
1. Tri-Step* 2. (3.6)	1. Tri-Step* 2. (3.6)	1. Tri-Step* 2. 3.6

Note: (x.xx) drill to the depth of the cortex only. All measurements are in mm.

⚠ CAUTION: The drill preparation is up to 1mm longer than the implants.

\* For initial drilling, you may use 2, 2.8 and 3.2 drills in sequence instead of the Tri-Step drill.

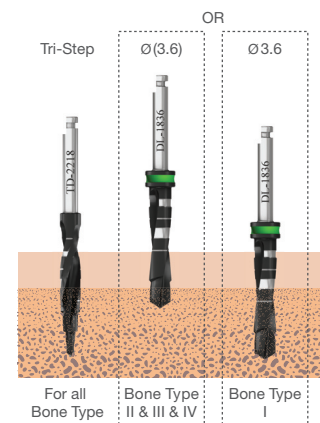

**TOUAREG™ - OS**    **Ø5.0**

OsseoFix™ Surface  
Titanium Grade 5

Catalog No.	Length mm	
ISF0650	6.25	
ISF0850	8	
ISF1050	10	
ISF1150	11.5	
ISF1350	13	
ISF1650	16	

**Drill Sequence**

BONE TYPE D-IV	BONE TYPE D-II & III	BONE TYPE D-I
1. Tri-Step*	1. Tri-Step*	1. Tri-Step*
2. 3.6	2. 3.6	2. 3.6
3. (4.2)	3. 4.2	3. 4.2
	4. (4.6)	4. 4.6

Note: (x.xx) drill to the depth of the cortex only.  
All measurements are in mm.

⚠ CAUTION: The drill preparation is up to 1mm longer than the implants.  
\* For initial drilling, you may use 2, 2.8 and 3.2 drills in sequence instead of the Tri-Step drill.

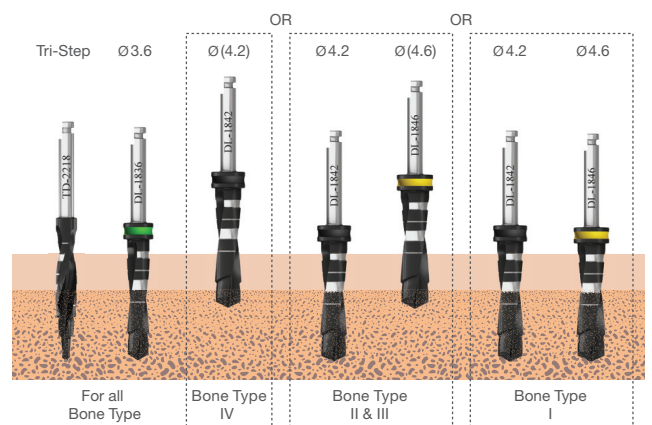

## TOUAREG™ - OS Ø6.0

OsseoFix™ Surface  
Titanium Grade 5

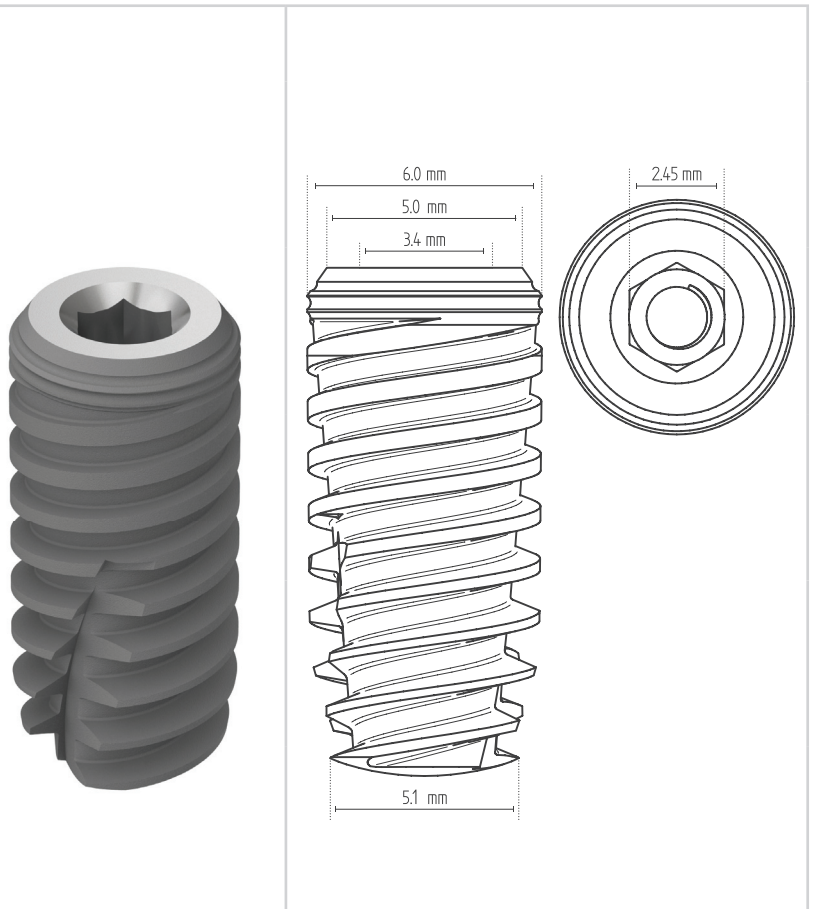
Catalog No.	Length mm	
ISF0660	6.25	
ISF0860	8	
ISF1060	10	
ISF1160	11.5	
ISF1360	13	

### Drill Sequence

BONE TYPE D-IV	BONE TYPE D-II & III	BONE TYPE D-I
1. Tri-Step*	1. Tri-Step*	1. Tri-Step*
2. 3.6	2. 3.6	2. 3.6
3. 4.2	3. 4.2	3. 4.2
4. (5.2)	4. 5.2	4. 5.2
	5. (5.6)	5. 5.6

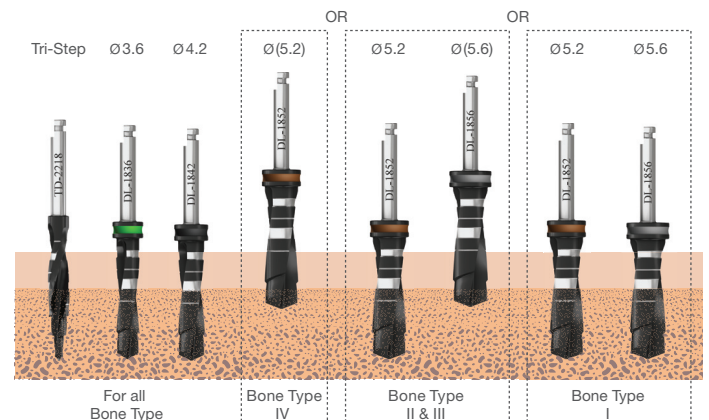

Note: (x.xx) drill to the depth of the cortex only.  
All measurements are in mm.

⚠ CAUTION: The drill preparation is up to 1mm longer than the implants.

\* For initial drilling, you may use 2, 2.8 and 3.2 drills in sequence instead of the Tri-Step drill.

**TOUAREG™ - S**    **Ø3.5**

AB/AE Surface  
Titanium Grade 5

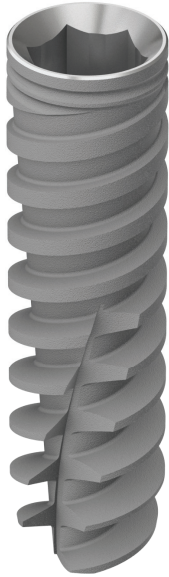
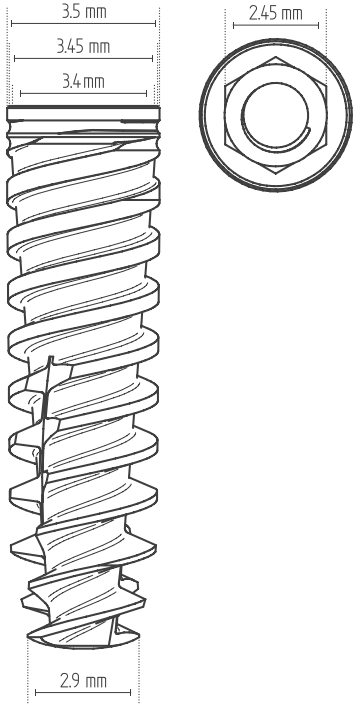
Catalog No.	Length mm		
ISPS0835	8		
ISPS1035	10		
ISPS1135	11.5		
ISPS1335	13		
ISPS1635	16		
ISPS1835	18		

**Drill Sequence**

BONE TYPE D-IV	BONE TYPE D-II & III	BONE TYPE D-I
1. Tri-Step*	1. Tri-Step* 2. (3.2)	1. Tri-Step* 2. (3.2)

Note: (x.xx) drill to the depth of the cortex only. All measurements are in mm.

⚠ CAUTION: The drill preparation is up to 1mm longer than the implants.

\* For initial drilling, you may use 2, 2.8 and 3.2 drills in sequence instead of the Tri-Step drill.

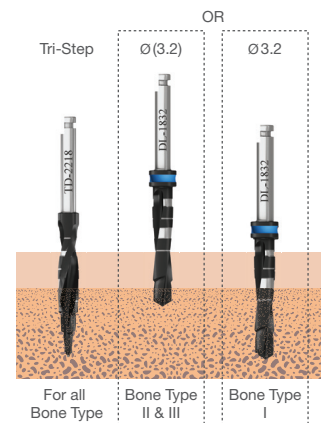

## TOUAREG™ - S $\varnothing$ 3.75

AB/AE Surface  
Titanium Grade 5

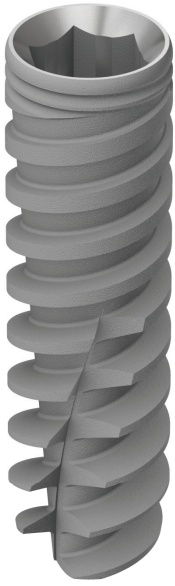
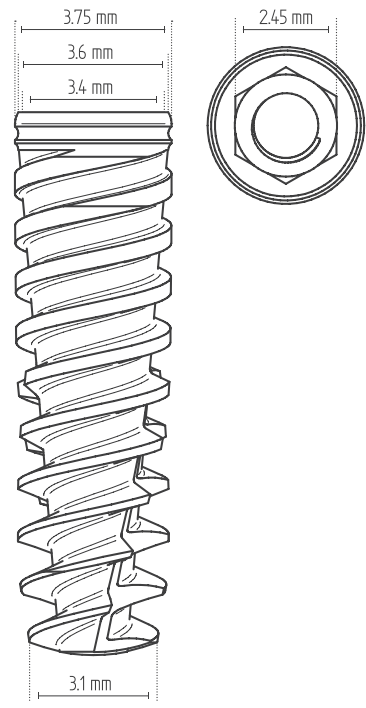
Catalog No.	Length mm		
ISPS0838	8		
ISPS1038	10		
ISPS1138	11.5		
ISPS1338	13		
ISPS1638	16		
ISPS1838	18		

### Drill Sequence

BONE TYPE D-IV	BONE TYPE D-II & III	BONE TYPE D-I
1. Tri-Step*	1. Tri-Step* 2. (3.2)	1. Tri-Step* 2. 3.2

Note: (x.xx) drill to the depth of the cortex only. All measurements are in mm.

⚠ CAUTION: The drill preparation is up to 1mm longer than the implants.

\* For initial drilling, you may use 2, 2.8 and 3.2 drills in sequence instead of the Tri-Step drill.

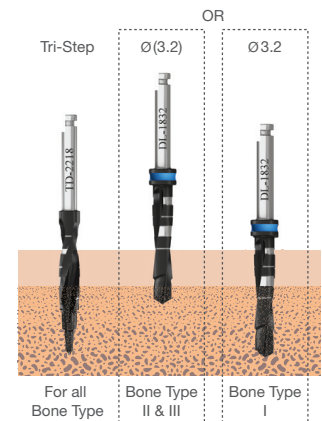

**TOUAREG™ - S**    **Ø4.2**

AB/AE Surface  
Titanium Grade 5

Catalog No.	Length mm		
ISPS0642	6.25		
ISPS0842	8		
ISPS1042	10		
ISPS1142	11.5		
ISPS1342	13		
ISPS1642	16		
ISPS1842	18		

**Drill Sequence**

BONE TYPE D-IV	BONE TYPE D-II & III	BONE TYPE D-I
1. Tri-Step* 2. (3.6)	1. Tri-Step* 2. (3.6)	1. Tri-Step* 2. 3.6

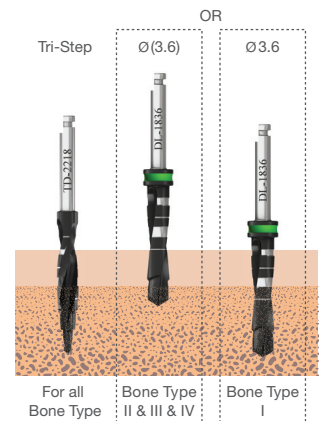

Note: (x.xx) drill to the depth of the cortex only. All measurements are in mm.

⚠ CAUTION: The drill preparation is up to 1mm longer than the implants.

\* For initial drilling, you may use 2, 2.8 and 3.2 drills in sequence instead of the Tri-Step drill.



## TOUAREG™ - S Ø5.0

AB/AE Surface  
Titanium Grade 5

Catalog No.	Length mm	
ISPS0650	6.25	
ISPS0850	8	
ISPS1050	10	
ISPS1150	11.5	
ISPS1350	13	
ISPS1650	16	

### Drill Sequence

BONE TYPE D-IV	BONE TYPE D-II & III	BONE TYPE D-I
1. Tri-Step*	1. Tri-Step*	1. Tri-Step*
2. 3.6	2. 3.6	2. 3.6
3. (4.2)	3. 4.2	3. 4.2
	4. (4.6)	4. 4.6

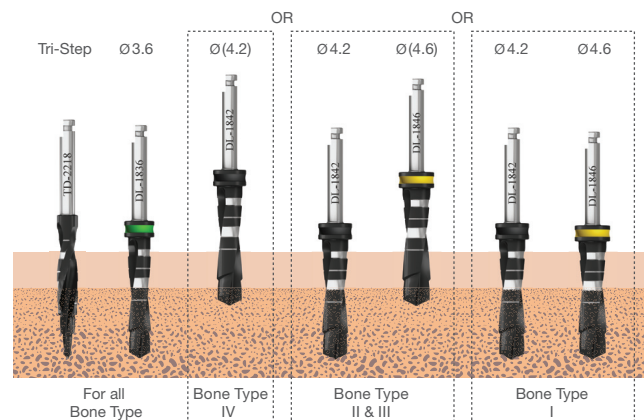

Note: (x.xx) drill to the depth of the cortex only.  
All measurements are in mm.

⚠ CAUTION: The drill preparation is up to 1mm longer than the implants.

\* For initial drilling, you may use 2, 2.8 and 3.2 drills in sequence instead of the Tri-Step drill.



**TOUAREG™ - S**    **Ø6.0**

AB/AE Surface  
Titanium Grade 5

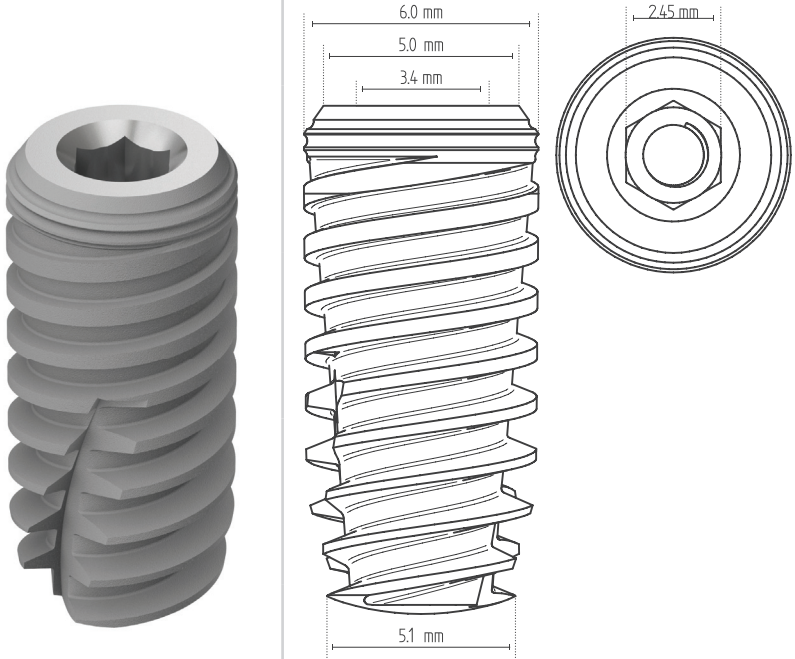
Catalog No.	Length mm	
ISPS0660	6.25	
ISPS0860	8	
ISPS1060	10	
ISPS1160	11.5	
ISPS1360	13	

**Drill Sequence**

BONE TYPE D-IV	BONE TYPE D-II & III	BONE TYPE D-I
1. Tri-Step*	1. Tri-Step*	1. Tri-Step*
2. 3.6	2. 3.6	2. 3.6
3. 4.2	3. 4.2	3. 4.2
4. (5.2)	4. 5.2	4. 5.2
	5. (5.6)	5. 5.6

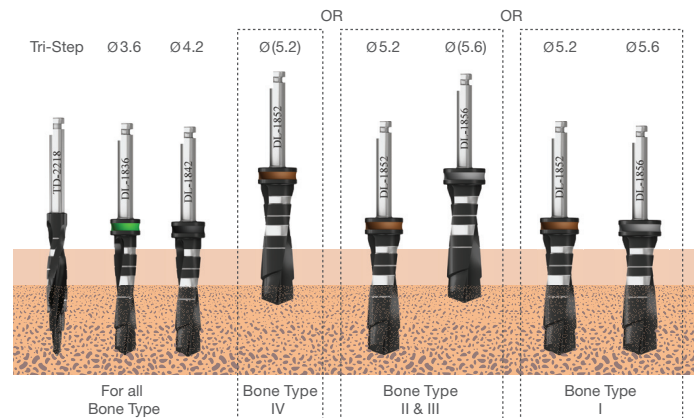

Note: (x.xx) drill to the depth of the cortex only.  
All measurements are in mm.

⚠ CAUTION: The drill preparation is up to 1mm longer than the implants.

\* For initial drilling, you may use 2, 2.8 and 3.2 drills in sequence instead of the Tri-Step drill.

# 38 | SWELL™

## Swell™ Straight Implant System

The Swell™ is a straight, parallel walled, slightly tapered implant with V-shaped thread design.

Its unique design allows for accurate positioning improved esthetics and better load distribution.

The Swell™ implant features the standard SLA™\* - AB/AE - Alumina Oxide Blasted/Acid Etched surface treatment.

\* Institut Straumann AG's trademark

**SWELL™** 

AB/AE surface treatment



	L-6.25mm	L-8mm	L-10mm	L-11.5mm	L-13mm	L-16mm	L-18mm
ID-3.3mmD			ID1033	ID1133	ID1333	ID1633	ID1833
ID-3.75mmD		ID0838	ID1038	ID1138	ID1338	ID1638	ID1838
ID-4.2mmD	ID0642	ID0842	ID1042	ID1142	ID1342	ID1642	ID1842
ID-5.0mmD	ID0650	ID0850	ID1050	ID1150	ID1350	ID1650	
ID-6.0mmD	ID0660	ID0860	ID1060	ID1160	ID1360		

**SWELL™** | **Ø3.3**

AB/AE Surface  
Titanium Grade 5

Catalog No.	Length mm		
ID1033	10		
ID1133	11.5		
ID1333	13		
ID1633	16		
ID1833	18		

**Drill Sequence**

BONE TYPE D-IV	BONE TYPE D-II & III	BONE TYPE D-I
1. 2.0 2. (2.8)	1. 2.0 2. (2.8) 3. (3.2)	1. Tri-Step*

Note: (x.xx) drill to the depth of the cortex only. All measurements are in mm.

⚠ CAUTION: The drill preparation is up to 1mm longer than the implants.

\* For initial drilling, you may use 2, 2.8 and 3.2 drills in sequence instead of the Tri-Step drill.

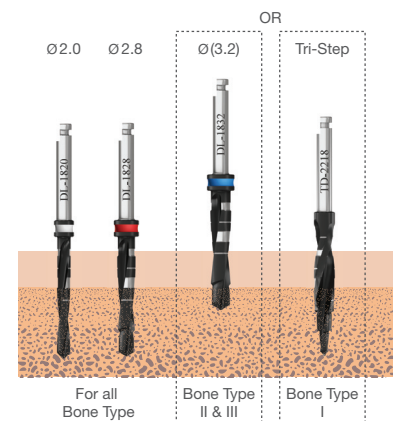

**SWELL™** **Ø3.75**

AB/AE Surface  
Titanium Grade 5

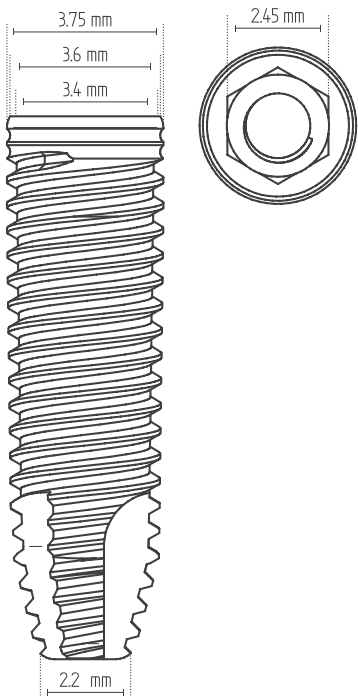
Catalog No.	Length mm		
ID0838	8		
ID1038	10		
ID1138	11.5		
ID1338	13		
ID1638	16		
ID1838	18		

## Drill Sequence

BONE TYPE D-IV	BONE TYPE D-II & III	BONE TYPE D-I
1. Tri-Step*	1. Tri-Step* 2. (3.2)	1. Tri-Step* 2. 3.2

Note: (x.xx) drill to the depth of the cortex only. All measurements are in mm.

⚠ CAUTION: The drill preparation is up to 1mm longer than the implants.

\* For initial drilling, you may use 2, 2.8 and 3.2 drills in sequence instead of the Tri-Step drill.

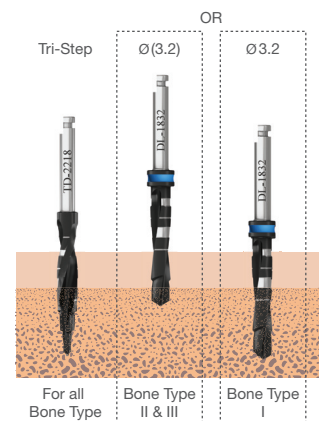

**SWELL™** **Ø4.2**

AB/AE Surface  
Titanium Grade 5

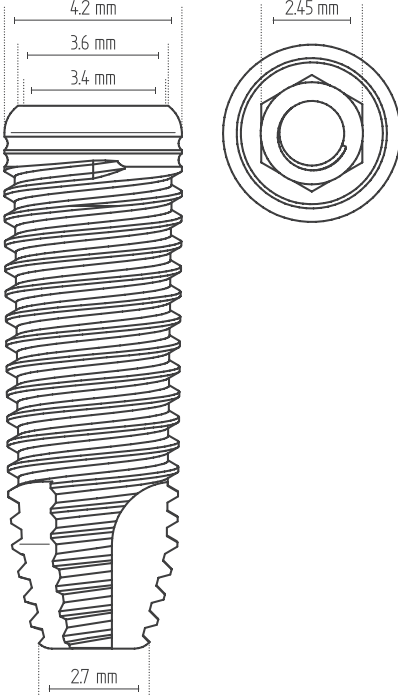
Catalog No.	Length mm		
ID0642	6.25		
ID0842	8		
ID1042	10		
ID1142	11.5		
ID1342	13		
ID1642	16		
ID1842	18		

**Drill Sequence**

BONE TYPE D-IV	BONE TYPE D-II & III	BONE TYPE D-I
1. Tri-Step* 2. 3.2	1. Tri-Step* 2. (3.6)	1. Tri-Step* 2. 3.6

Note: (x.xx) drill to the depth of the cortex only. All measurements are in mm.

⚠ CAUTION: The drill preparation is up to 1mm longer than the implants.

\* For initial drilling, you may use 2, 2.8 and 3.2 drills in sequence instead of the Tri-Step drill.

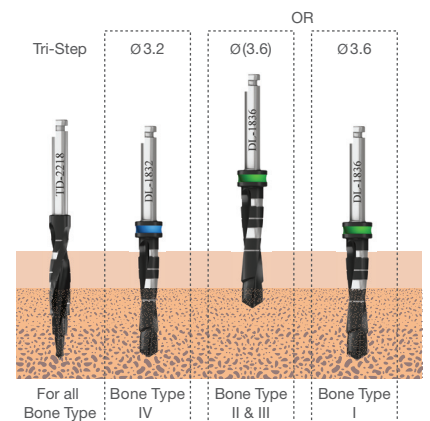

## SWELL™ Ø5.0

AB/AE Surface  
Titanium Grade 5

Catalog No.	Length mm	
ID0650	6.25	
ID0850	8	
ID1050	10	
ID1150	11.5	
ID1350	13	
ID1650	16	

### Drill Sequence

BONE TYPE D-IV	BONE TYPE D-II & III	BONE TYPE D-I
1. Tri-Step*	1. Tri-Step*	1. Tri-Step*
2. 3.6	2. 3.6	2. 3.6
3. (4.2)	3. 4.2	3. 4.2
	4. (4.6)	4. 4.6

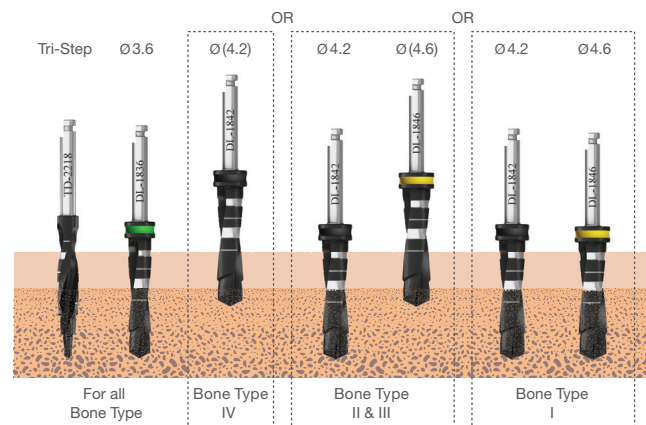

Note: (x.xx) drill to the depth of the cortex only.  
All measurements are in mm.

⚠ CAUTION: The drill preparation is up to 1mm longer than the implants.  
\* For initial drilling, you may use 2, 2.8 and 3.2 drills in sequence instead of the Tri-Step drill.

**SWELL™** **Ø6.0**

AB/AE Surface  
Titanium Grade 5

Catalog No.	Length mm	
ID0660	6.25	
ID0860	8	
ID1060	10	
ID1160	11.5	
ID1360	13	

**Drill Sequence**

BONE TYPE D-IV	BONE TYPE D-II & III	BONE TYPE D-I
1. Tri-Step*	1. Tri-Step*	1. Tri-Step*
2. 3.6	2. 3.6	2. 3.6
3. 4.2	3. 4.2	3. 4.2
4. 4.6	4. 4.6	4. 4.6
5. (5.2)	5. 5.2	5. 5.2
	6. (5.6)	6. (5.6)

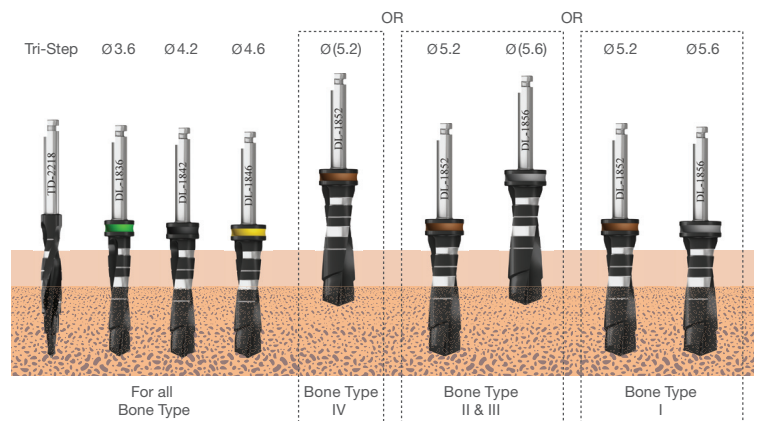

Note: (x.xx) drill to the depth of the cortex only.  
All measurements are in mm.

⚠ CAUTION: The drill preparation is up to 1mm longer than the implants.

\* For initial drilling, you may use 2, 2.8 and 3.2 drills in sequence instead of the Tri-Step drill.



#### Healing Abutments





















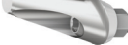

	RS3027	RS Slim Healing Abutment 3.5mmD x 2mmL	Ti Grade 5
	RS3028	RS Slim Healing Abutment 3.5mmD x 3mmL	Ti Grade 5
	RS3029	RS Slim Healing Abutment 3.5mmD x 4mmL	Ti Grade 5
	RS3030	RS Slim Healing Abutment 3.5mmD x 5mmL	Ti Grade 5
	RS3031	RS Slim Healing Abutment 3.5mmD x 6mmL	Ti Grade 5
	RS3022	RS Healing Abutment 4.5mmD x 2mmL	Ti Grade 5
	RS3023	RS Healing Abutment 4.5mmD x 3mmL	Ti Grade 5
	RS3024	RS Healing Abutment 4.5mmD x 4mmL	Ti Grade 5
	RS3025	RS Healing Abutment 4.5mmD x 5mmL	Ti Grade 5
	RS3026	RS Healing Abutment 4.5mmD x 6mmL	Ti Grade 5
	RS3012	RS Wide Healing Abutment 6mmD x 2mmL	Ti Grade 5
	RS3013	RS Wide Healing Abutment 6mmD x 3mmL	Ti Grade 5
	RS3014	RS Wide Healing Abutment 6mmD x 4mmL	Ti Grade 5
	RS3015	RS Wide Healing Abutment 6mmD x 5mmL	Ti Grade 5

#### Cement Retained

	RS3903	RS Slim Titanium Abutment 3mm	Ti Grade 5
	RS3906	RS Slim Titanium Abutment 6mm	Ti Grade 5
	RS3908	RS Slim Titanium Abutment 8mm	Ti Grade 5
	RS3800	RS Straight Titanium Abutment - No End Line	Ti Grade 5
	RS3801	RS Straight Titanium Abutment 1mm	Ti Grade 5
	RS3802	RS Straight Titanium Abutment 2mm	Ti Grade 5
	RS3803	RS Straight Titanium Abutment 3mm	Ti Grade 5
	RS3804	RS Straight Titanium Abutment 4mm	Ti Grade 5
	RS3805	RS Straight Titanium Abutment 5 mm	Ti Grade 5
	RS3811	RS Straight Titanium Abutment Long 12.5mm	Ti Grade 5
	RS3950	RS Titanium Abutment 5.0 mmD Wide	Ti Grade 5

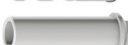

Cement Retained

	RS0010	RS Straight Abutment 1mmL	Ti Grade 5
	RS0011	RS Straight Abutment 2mmL	Ti Grade 5
	RS0012	RS Straight Abutment 3mmL	Ti Grade 5
	RS3890	RS Wide Profile Titanium Abutment	Ti Grade 5
	RS3411	RS Straight Cylindrical Titanium Abutment 2mm	Ti Grade 5
	RS3422	RS Non-Engaging Straight Cylindrical Titanium Abutment 2mm	Ti Grade 5
	RS3812	RS One Piece Screw-in Abutment	Ti Grade 5
	RS4015	RS Angled Titanium Abutment 15°	Ti Grade 5
	RS4016	RS Angled Titanium Abutment 15° - Long	Ti Grade 5
	RS4017	RS Slim Angled Abutment 15° 1mm - No End Line	Ti Grade 5
	RS4018	RS Slim Angled Abutment 15° 2mm - No End Line	Ti Grade 5
	RS4019	RS Slim Angled Abutment 15° 3mm - No End Line	Ti Grade 5
	RS4025	RS Angled Titanium Abutment 25°	Ti Grade 5
	RS4035	RS Angled Titanium Abutment 35°	Ti Grade 5
	RS4115	RS Esthetic Angled Titanium Abutment 15° 1mm	Ti Grade 5
	RS4117	RS Esthetic Angled Titanium Abutment 15° 2mm	Ti Grade 5
	RS4119	RS Esthetic Angled Titanium Abutment 15° 3mm	Ti Grade 5
	RS3090	RS Engaging Gold / Plastic Abutment	Gold/Plastic
	RS3095	RS Engaging Titanium / Plastic Abutment	Ti Grade 5 / Plastic
	RS3097	RS Non Engaging Titanium/Plastic Abutment	Ti Grade 5 / Plastic
	RS5000	RS Engaging Plastic Cylinder Casting Abutment	Plastic
	RS5020	RS Non-Engaging Plastic Cylinder Casting Abutment	Plastic
	RS5030	RS Engaging Plastic Standard Abutment	Plastic
	RS5050	RS Non-Engaging Plastic Standard Abutment	Plastic
	RS5010	RS Engaging Plastic Casting Standard Abutment	Plastic
	RS5040	RS Engaging Plastic Cylinder Abutment	Plastic



## Cement Retained - Zirconium Abutments

	ZA0005	RS Straight Zirconium Abutment w / Titanium Base	Zirconium + Ti Grade 5
	ZA0007	RS Angled Zirconium Abutment 15° w / Titanium Base	Zirconium + Ti Grade 5
	ZA1005	RS Straight Zirconium Abutment w / Titanium Base 1mm	Zirconium + Ti Grade 5
	ZA1006	RS Straight Zirconium Abutment w / Titanium Base 2mm	Zirconium + Ti Grade 5
	ZA1007	RS Straight Zirconium Abutment w / Titanium Base 3mm	Zirconium + Ti Grade 5
	ZA1008	RS Straight Zirconium Abutment w / Titanium Base 4mm	Zirconium + Ti Grade 5
	ZA1009	RS Straight Zirconium Abutment w / Titanium Base 5mm	Zirconium + Ti Grade 5
	ZA1015	RS Angled Zirconium Abutment w / Titanium Base 1mm	Zirconium + Ti Grade 5
	ZA1016	RS Angled Zirconium Abutment w / Titanium Base 2mm	Zirconium + Ti Grade 5
	ZA1017	RS Angled Zirconium Abutment w / Titanium Base 3mm	Zirconium + Ti Grade 5
	ZA1018	RS Angled Zirconium Abutment w / Titanium Base 4mm	Zirconium + Ti Grade 5
	ZA1019	RS Angled Zirconium Abutment w / Titanium Base 5mm	Zirconium + Ti Grade 5

## Screw Retained - MU Trans Mucosal Abutments (TMA™)

	RS3731	RS Straight Trans Mucosal Abutment 1mm	Ti Grade 5
	RS3732	RS Straight Trans Mucosal Abutment 2mm	Ti Grade 5
	RS3733	RS Straight Trans Mucosal Abutment 3mm	Ti Grade 5
	RS3729	RS Straight Trans Mucosal Abutment 4mm	Ti Grade 5
	RS3730	RS Straight Trans Mucosal Abutment 5mm	Ti Grade 5
	RS3734	RS Angled Trans Mucosal Abutment 17° 2mm	Ti Grade 5
	RS3737	RS Angled Trans Mucosal Abutment 17° 3mm	Ti Grade 5
	RS3735	RS Angled Trans Mucosal Abutment 30° 3mm	Ti Grade 5
	RS3738	RS Angled Trans Mucosal Abutment 30° 4mm	Ti Grade 5
	RS3736	RS Angled Trans Mucosal Abutment 45° 4mm	Ti Grade 5
	RS5005	TMA Healing Cap	Ti Grade 5
	RS4900	TMA Titanium Temporary Copying	Ti Grade 5
	RS5001	TMA Plastic Casting Sleeve w / Prosthetic Screw	Plastic
	RS5004	TMA Abutment Replica	Ti Grade 5

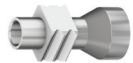











**Screw Retained - MU Trans Mucosal Abutments (TMA™)**

	RS5006	TMA Impression Coping Open Tray	Ti Grade 5
	RS5011	RS TMA Closed Tray Transfer	Ti Grade 5





**Flat Connection**

	FC4502	Flat Connection Abutment 2mm	Ti Grade 5
	FC4504	Flat Connection Abutment 4mm	Ti Grade 5
	FC5512	Flat Connection Transfer Impression Coping	Ti Grade 5
	FC5515	Flat Connection Temporary Cylinder Sleeve	Ti Grade 5
	FC5737	Flat Connection Implant Replica	Stainless Steel
	FC6011	Flat Connection Castable Abutment for Centering Ring	Plastic
	FC6015	Flat Connection Titanium Retaining Screw	Ti Grade 5
	FC6013	Flat Connection Titanium Gluing Ring	Ti Grade 5
	FC6017	Flat Connection Long Laboratory Screw	Ti Grade 5
	FC6018	Flat Connection Centering Ring	Ti Grade 5

**Ball Attachment - Overdentures**

	RS2861	RS Ball Attachment 1mm w / Hex	Ti Grade 5
	RS2862	RS Ball Attachment 2mm w / Hex	Ti Grade 5
	RS2863	RS Ball Attachment 3mm w / hex	Ti Grade 5
	RS2864	RS Ball Attachment 4mm w / Hex	Ti Grade 5
	RS2865	RS Ball Attachment 5mm w / Hex	Ti Grade 5
	RS2866	RS Ball Attachment 6mm w / Hex	Ti Grade 5
	RS2650	RS Ball Attachment 0.5 mm	Ti Grade 5
	RS2651	RS Ball Attachment 1 mm	Ti Grade 5
	RS2652	RS Ball Attachment 2 mm	Ti Grade 5
	RS2653	RS Ball Attachment 3 mm	Ti Grade 5
	RS2654	RS Ball Attachment 4 mm	Ti Grade 5
	RS2655	RS Ball Attachment 5 mm	Ti Grade 5

## Ball Attachment - Overdentures

	RS2660	Plastic Ball Cap - White	Nylon
	RS2662	Plastic Ball Cap Pink - Soft	Nylon
	RS2670	Titanium Ball Cap	Ti Grade 5
	RS2675SS	Stainless Steel Ball Cap	Stainless Steel





## Prosthetic Hand Drivers

	RS6095	1.27 Hex Hand Driver - Short	Stainless Steel
	RS6094	1.27 Hex Hand Driver - Medium	Stainless Steel
	RS6097	1.27 Hex Hand Driver - Long	Stainless Steel
	RS6191	TMA/FC Female Hand Hex Driver - Long	Stainless Steel
	RS6193	TMA/FC Female Hand Hex Driver - Short	Stainless Steel



## Torque Drivers

	RS6090	Torque Driver for Ball Attachment	Stainless Steel
	RS6011	RS 2.4 Hex Torque Driver - Short	Stainless Steel
	RS6012	RS 2.4 Hex Torque Driver - Long	Stainless Steel
	RS6197	TMA/FC Hex Torque Driver - Short	Stainless Steel
	RS6196	TMA/FC Hex Torque Driver - Long	Stainless Steel
	RS6080	1.27 Hex Torque Driver - Short	Stainless Steel
	RS6082	1.27 Hex Torque Driver - Long	Stainless Steel





## Handpiece Drivers and Adaptors

	RS9020	RS Hex Handpiece Adapter - Short	Stainless Steel
	RS9025	RS Hex Handpiece Adapter - Long	Stainless Steel
	RS9030	1.27 Hex Driver for Handpiece - Short	Stainless Steel
	RS9035	1.27 Hex Driver for Handpiece - Long	Stainless Steel
	RS6194	TMA/FC Hex Handpiece Adapter - Short	Stainless Steel
	RS6195A	TMA/FC Hex Handpiece Adapter - Long	Stainless Steel

**Analogs**

	RS5737	RS Internal Hex Implant Analog	Stainless Steel
	RS5740	Ball Attachment Abutment Replica	Stainless Steel















**Transfers (Implant Level)**

	RS5509	RS Closed Tray Transfer 9 mm	Stainless Steel
	RS5512	RS Closed Tray Transfer 12 mm	Stainless Steel
	RS5600	RS Slim Closed Tray Transfer	Stainless Steel
	RS5610	RS Open Tray Transfer	Stainless Steel

**RS Retrieval Screw**

	RS3401	RS Retrieval Screw For Abutments	Ti Grade 5
---	--------	----------------------------------	------------

**RS Screws**

	RS3435	RS Implant Cover Screw	Ti Grade 5
	RS3400	RS Prosthetic Screw	Ti Grade 5
	RS3402	RS Short Prosthetic Screw	Ti Grade 5
	RS3480	RS Screw for Angled Titanium Abutment	Ti Grade 5
	RS3403	RS Retaining Screw For Angled TMA	Ti Grade 5
	RS3404	TMA Prosthetic Screw	Ti Grade 5
	RS3406	RS Retaining Screw for TMA 1mm	Ti Grade 5
	RS3407	RS Retaining Screw for TMA 2mm	Ti Grade 5
	RS3408	RS Retaining Screw for TMA 3mm	Ti Grade 5
	RS3409	RS Retaining Screw for TMA 4mm	Ti Grade 5
	RS3412	RS Retaining Screw for TMA 5mm	Ti Grade 5
	RS5008	TMA Screw For Open Tray Impression Copying	Ti Grade 5
	RS3424	RS Screw for Esthetic Connection	Ti Grade 5
	RS3425	RS Screw For Closed Tray Transfer	Ti Grade 5
	RS3427	RS Screw for Esthetic Connection Abutment 1.5mm	Ti Grade 5

# 50 | ONE™

## One Piece Implant System

One™ is a tapered core spiral implant. It is as easy to use as a regular crown and bridge dentistry.



- Minimally invasive surgery - narrow diameter
- Immediate Function / Loading
- Designed for narrow ridges
- Offers fast and easy flapless procedure
- One™ implants with narrow diameters are highly suitable replacements for laterals in the maxilla and incisors in the mandible.

ONE™   
AB/AE surface treatment



	L-10mm	L-11.5mm	L-13mm	L-15mm
D3.0mm	IO1030	IO1130	IO1330	IO1530
D3.3mm	IO1033	IO1133	IO1333	IO1533
D3.6mm	IO1036	IO1136	IO1336	IO1536
D4.2mm	IO1042	IO1142	IO1342	IO1542
D5.0mm	IO1050	IO1150	IO1350	IO1550

packed with:

- |           |   |        |                                    |                 |
|-----------|---|--------|------------------------------------|-----------------|
| Optional: |  | RS6025 | RS One Piece Torque Driver - Short | Stainless Steel |
|           |  | RS6026 | RS One Piece Torque Driver - Long  | Stainless Steel |



**ONE™** **Ø3.0**

AB/AE Surface  
Titanium Grade 5

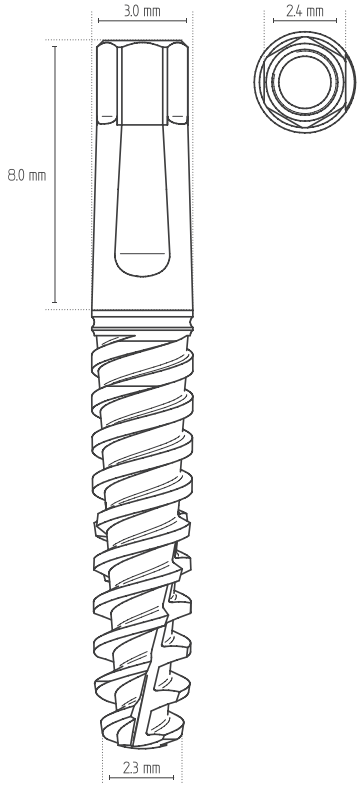
Catalog No.	Length mm		
IO1030	10		
IO1130	11.5		
IO1330	13		
IO1530	15		

### Drill Sequence

BONE TYPE D-IV	BONE TYPE D-II & III	BONE TYPE D-I
1. 2.0	1. 2.0 2. (2.8)	1. 2.0 2. 2.8

Note: (x.xx) drill to the depth of the cortex only. All measurements are in mm.

⚠ CAUTION: The drill preparation is up to 1mm longer than the implants.

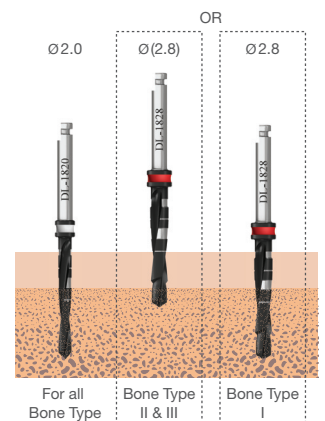

ONE™ Ø3.3

AB/AE Surface  
Titanium Grade 5

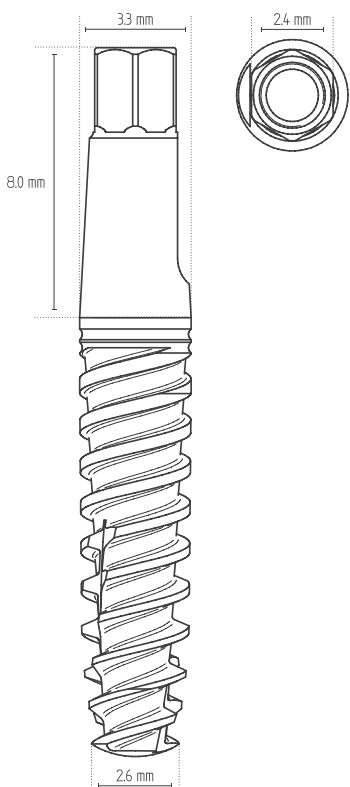
Catalog No.	Length mm		
IO1033	10		
IO1133	11.5		
IO1333	13		
IO1533	15		

## Drill Sequence

BONE TYPE D-IV	BONE TYPE D-II & III	BONE TYPE D-I
1. 2.0	1. 2.0 2. (2.8)	1. 2.0 2. 2.8

Note: (x.xx) drill to the depth of the cortex only. All measurements are in mm.

⚠ CAUTION: The drill preparation is up to 1mm longer than the implants.

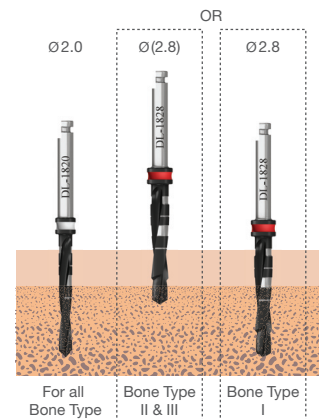

ONE™ Ø3.6

AB/AE Surface  
Titanium Grade 5

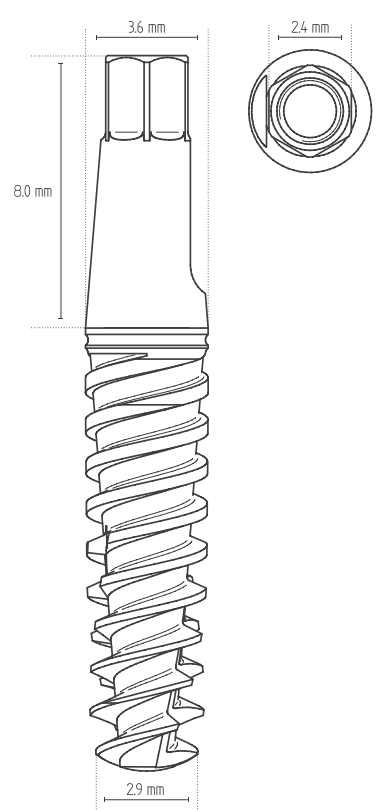
Catalog No.	Length mm		
IO1036	10		
IO1136	11.5		
IO1336	13		
IO1536	15		

### Drill Sequence

BONE TYPE D-IV	BONE TYPE D-II & III	BONE TYPE D-I
1. Tri-Step*	1. Tri-Step* 2. (3.2)	1. Tri-Step* 2. (3.2)

Note: (x.xx) drill to the depth of the cortex only. All measurements are in mm.

⚠ CAUTION: The drill preparation is up to 1mm longer than the implants.

\* For initial drilling, you may use 2, 2.8 and 3.2 drills in sequence instead of the Tri-Step drill.

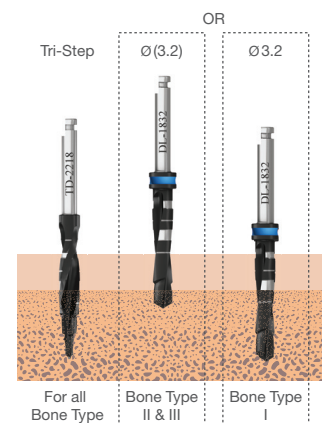

ONE™ Ø4.2

AB/AE Surface  
Titanium Grade 5

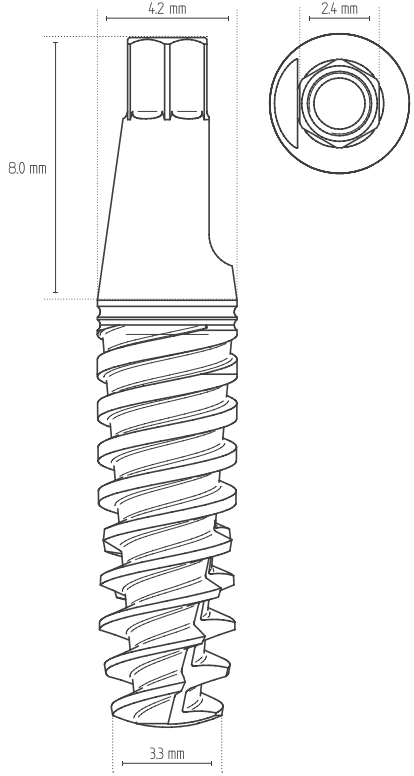
Catalog No.	Length mm		
IO1042	10		
IO1142	11.5		
IO1342	13		
IO1542	15		

## Drill Sequence

BONE TYPE D-IV	BONE TYPE D-II & III	BONE TYPE D-I
1. Tri-Step* 2. (3.6)	1. Tri-Step* 2. (3.6)	1. Tri-Step* 2. 3.6

Note: (x.xx) drill to the depth of the cortex only. All measurements are in mm.

⚠ CAUTION: The drill preparation is up to 1mm longer than the implants.

\* For initial drilling, you may use 2, 2.8 and 3.2 drills in sequence instead of the Tri-Step drill.

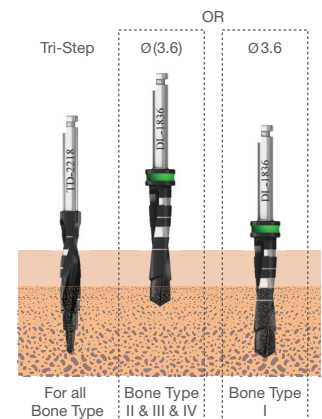

ONE™ Ø5.0

AB/AE Surface  
Titanium Grade 5

Catalog No.	Length mm	
IO1050	10	
IO1150	11.5	
IO1350	13	
IO1550	15	

### Drill Sequence

BONE TYPE D-IV	BONE TYPE D-II & III	BONE TYPE D-I
1. Tri-Step*	1. Tri-Step*	1. Tri-Step*
2. 3.6	2. 3.6	2. 3.6
3. (4.2)	3. 4.2	3. 4.2
	4. (4.6)	4. 4.6

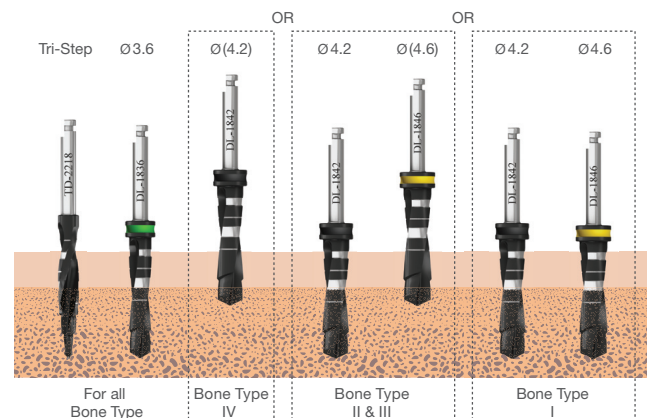

Note: (x.xx) drill to the depth of the cortex only.  
All measurements are in mm.

⚠ CAUTION: The drill preparation is up to 1mm longer than the implants.

\* For initial drilling, you may use 2, 2.8 and 3.2 drills in sequence instead of the Tri-Step drill.

# 56 Kits & Tools

## Toureg CloseFit™ Surgical Kit

### CF6300: Toureg CloseFit™ Plastic Surgical Kit - Premium

RS6111	Surgical Torque Ratchet 35 -100Ncm	DL1828	Twist Step Drill 2.3/2.8mmD x 8-18mmL
RS6180	Depth Probe	DL1832	Twist Step Drill 2.8/3.2mmD x 8-18mmL
NP0005	NP 2mm Torque Driver - Long	DL1836	Twist Step Drill 3.2/3.6mmD x 8-18mmL
NP0006	NP 2mm Torque Driver - Short	DL1842	Twist Step Drill 3.8/4.2mmD x 8-18mmL
RP0066	RP 2.2mm Hex Torque Driver - Long	DL1846	Twist Step Drill 4.2/4.6mmD x 8-18mmL
RP0067	RP 2.2mm Hex Torque Driver - Short	TD1511	Three Step Drill - Short
WP0067	WP 2.6mm Torque Driver - Short	TD2218	Three Step Drill - Long
WP0066	WP 2.6mm Torque Driver - Long	RS8032	Tip Drill
NP0062	NP 2mm Hex Handpiece Adapter - Short	RS9027	Drill Extension
NP0072	NP 2mm Hex Handpiece Adapter - Long	RP0005	Star Torque Driver - Long
RP0062	RP Handpiece Hex Adapter - Short	RP0065	Star Torque Driver - Short
RP0072	RP Handpiece Hex Adapter - Long	RP0064	Star Hand Driver - Short
WP0062	WP Handpiece Hex Adapter - Short	RP0004	Star Hand Driver - Long
WP0072	WP Handpiece Hex Adapter - Long	RP0018	Star Handpiece Driver - Short
RS6150	Parallel Pin 11 (4 Pieces)	RP0019	Star Handpiece Driver - Long
RS6155	Parallel Pin 16 (2 Pieces)	RS6191	TMA/FC Female Hand Hex Driver - Long
DL1820	Pilot Drill 2mmD x 8-18mmL	RS6193	TMA/FC Female Hand Hex Driver - Short
		CF6301	Toureg CloseFit™ Surgical Tray

### CF6302: Toureg CloseFit™ Plastic Surgical Kit - Advanced

RS6180	Depth Probe	DL1820	Pilot Drill 2mmD x 8-18mmL
RS9027	Drill Extension	DL1828	Twist Step Drill 2.3/2.8mmD x 8-18mmL
NP0005	NP 2mm Torque Driver - Long	DL1832	Twist Step Drill 2.8/3.2mmD x 8-18mmL
NP0006	NP 2mm Torque Driver - Short	DL1836	Twist Step Drill 3.2/3.6mmD x 8-18mmL
RS6150	Parallel Pin 11 (4 Pieces)	DL1842	Twist Step Drill 3.8/4.2mmD x 8-18mmL
RS6155	Parallel Pin 16 (2 Pieces)	DL1846	Twist Step Drill 4.2/4.6mmD x 8-18mmL
RP0067	RP 2.2mm Hex Torque Driver - Short	WP0066	WP 2.6mm Torque Driver - Long
RP0066	RP 2.2mm Hex Torque Driver - Long	WP0067	WP 2.6mm Torque Driver - Short
RP0004	Star Hand Driver - Long	RP0019	Star Handpiece Driver - Long
RP0064	Star Hand Driver - Short	RP0018	Star Handpiece Driver - Short
RS6111	Surgical Torque Ratchet 35-100 Ncm	CF6301	Toureg CloseFit™ Surgical Tray

### CF6303: Toureg CloseFit™ Plastic Surgical Kit - Starter

NP0005	NP 2mm Torque Driver - Long	DL1820	Pilot Drill 2mmD x 8-18mmL
NP0006	NP 2mm Torque Driver - Short	DL1828	Twist Step Drill 2.3/2.8mmD x 8-18mmL
RP0067	RP 2.2mm Hex Torque Driver - Short	DL1832	Twist Step Drill 2.8/3.2mmD x 8-18mmL
RP0066	RP 2.2mm Hex Torque Driver - Long	DL1836	Twist Step Drill 3.2/3.6mmD x 8-18mmL
RP0004	Star Hand Driver - Long	RP0019	Star Handpiece Driver - Long
RP0064	Star Hand Driver - Short	RP0018	Star Handpiece Driver - Short
WP0066	WP 2.6mm Torque Driver - Long	RS6100	Wrench Ratchet
WP0067	WP 2.6mm Torque Driver - Short	CF6301	Toureg CloseFit™ Surgical Tray



### Touareg CloseFit™ Surgical Kit

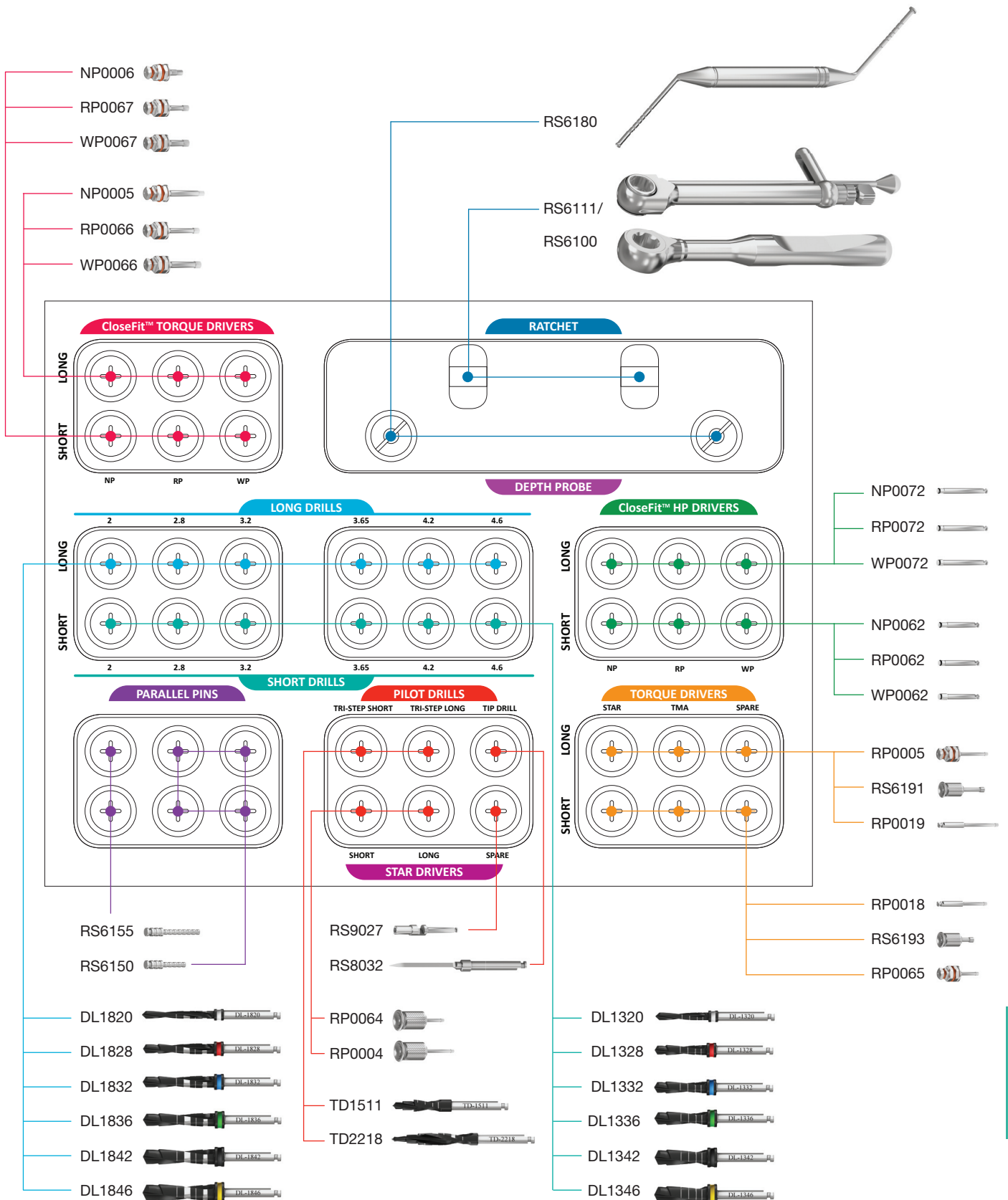

## Toureg™ RS - Standard Internal Hex Surgical Kit

### RS6301: RS - Standard Internal Hex Plastic Surgical Kit - Premium

RS6111	Surgical Torque Ratchet 35-100Ncm	RS9027	Drill Extension
RS6180	Depth Probe	RS9021	RS Hex Handpiece Adapter - Short
DL1820	Pilot Drill 2mmD x 8-18mmL	RS9026	RS Hex Handpiece Adapter - Medium
DL1828	Twist Step Drill 2.3/2.8mmD x 8-18mmL	RS9029	RS Hex Handpiece Adapter - Long
DL1832	Twist Step Drill 2.8/3.2mmD x 8-18mmL	RA0040	Torque Ratchet Surgical Instruments Handle
DL1836	Twist Step Drill 3.2/3.6mmD x 8-18mmL	RS6150	Parallel Pin 11 (4 Pieces)
DL1842	Twist Step Drill 3.8/4.2mmD x 8-18mmL	RS6155	Parallel Pin 16 (2 Pieces)
DL1846	Twist Step Drill 4.2/4.6mmD x 8-18mmL	RS6094	1.27 Hex Hand Driver - Medium
DL1852	Twist Step Drill 4.8/5.2mmD x 8-18mmL	RS6095	1.27 Hex Hand Driver - Short
DL1856	Twist Step Drill 5.2/5.6mmD x 8-18mmL	RS6191	TMA/FC Female Hand Hex Driver - Long
TD1511	Three Step Drill - Short	RS6193	TMA/FC Female Hand Hex Driver - Short
TD2218	Three Step Drill - Long	RS6080	1.27 Hex Torque Driver - Short
RS8032	Tip Drill	RS6082	1.27 Hex Torque Driver - Long

### RS6322: RS - Standard Internal Hex Plastic Surgical Kit - Advanced

RS6111	Surgical Torque Ratchet 35-100 Ncm	RS9021	RS Hex Handpiece Adapter - Short
RS6180	Depth Probe	RS9026	RS Hex Handpiece Adapter - Medium
DL1820	Pilot Drill 2mmD x 8-18mmL	RS9029	RS Hex Handpiece Adapter - Long
DL1828	Twist Step Drill 2.3/2.8mmD x 8-18mm	RA0040	Torque Ratchet Surgical Instruments Handle
DL1832	Twist Step Drill 2.8/3.2mmD x 8-18mmL	RS6150	Parallel Pin 11 (4 Pieces)
DL1836	Twist Step Drill 3.2/3.6mmD x 8-18mmL	RS6155	Parallel Pin 16 (2 Pieces)
DL1842	Twist Step Drill 3.8/4.2mmD x 8-18mmL	RS6094	1.27 Hex Hand Driver - Medium
DL1846	Twist Step Drill 4.2/4.6mmD x 8-18mmL	RS6095	1.27 Hex Hand Driver - Short
RS9027	Drill Extension	RS6080	1.27 Hex Torque Driver - Short
		RS6082	1.27 Hex Torque Driver - Long

### RS6333: RS - Standard Internal Hex Plastic Surgical Kit - Starter

RS6100	Wrench Ratchet	RS9021	RS Hex Handpiece Adapter - Short
DL1820	Pilot Drill 2mmD x 8-18mmL	RS9026	RS Hex Handpiece Adapter - Medium
DL1828	Twist Step Drill 2.3/2.8mmD x 8-18mmL	RS9029	RS Hex Handpiece Adapter - Long
DL1832	Twist Step Drill 2.8/3.2mmD x 8-18mmL	RA0050	Wrench Ratchet Surgical Instruments Handle
DL1836	Twist Step Drill 3.2/3.6mmD x 8-18mmL	RS6094	1.27 Hex Hand Driver - Medium
DL1842	Twist Step Drill 3.8/4.2mmD x 8-18mmL	RS6095	1.27 Hex Hand Driver - Short
DL1846	Twist Step Drill 4.2/4.6mmD x 8-18mmL	RS6080	1.27 Hex Torque Driver - Short
		RS6082	1.27 Hex Torque Driver - Long

## Touareg™ RS - Standard Internal Hex Surgical Kit

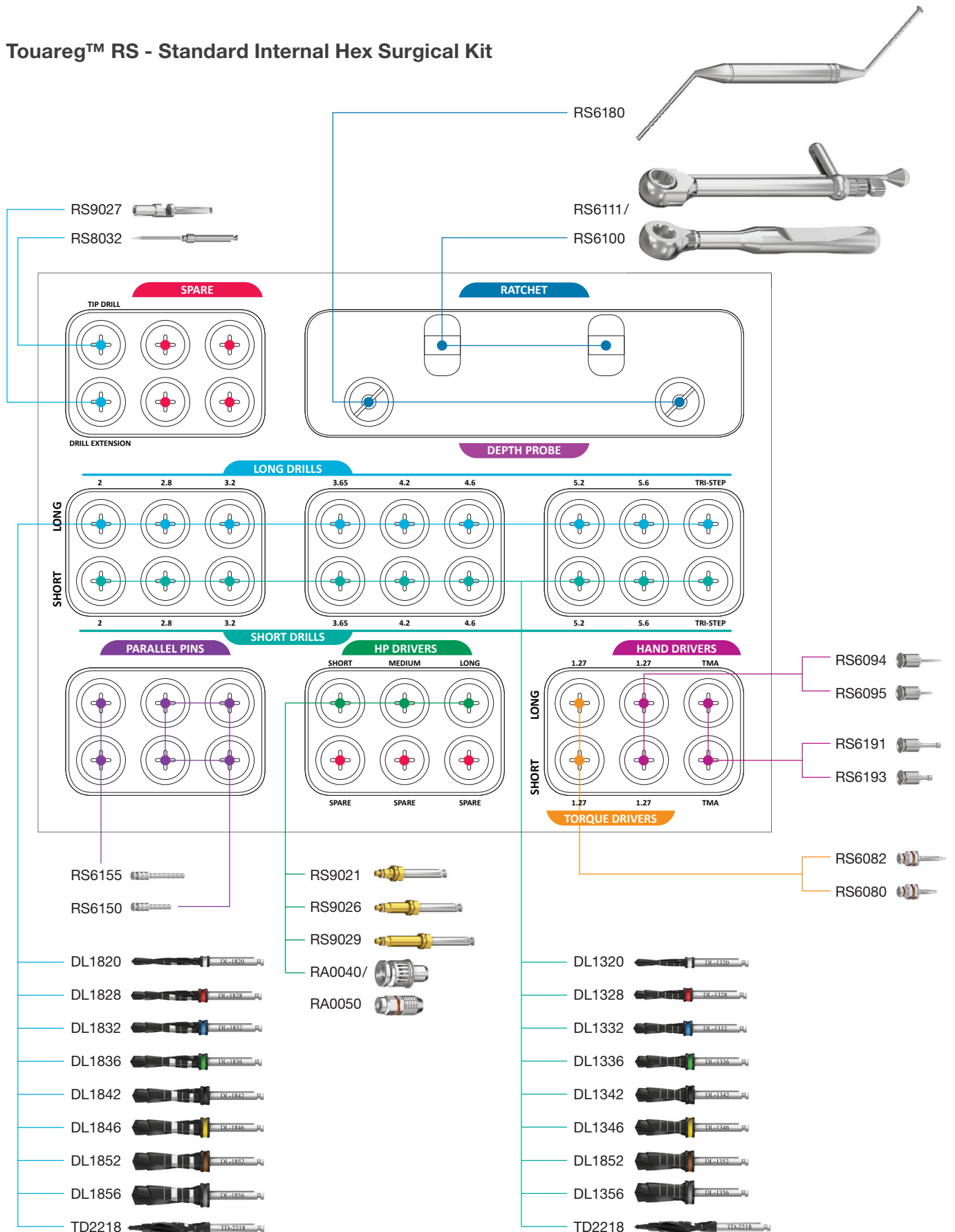

## Prosthetic Kit

### PK6300: Prosthetic Kit

RS6112	Prosthetic Torque Ratchet 15-35 Ncm
RS6095	1.27 Hex Hand Driver - Short
RS6094	1.27 Hex Hand Driver - Medium
RS6080	1.27 Hex Torque Driver - Short
RS6082	1.27 Hex Torque Driver - Long
RS9030	1.27 Hex Driver for Handpiece - Short
RS9035	1.27 Hex Driver for Handpiece - Long
RS6191	TMA/FC Female Hand Hex Driver - Long
RS6193	TMA/FC Female Hand Hex Driver - Short
RS6197	TMA/FC Hex Torque Driver - Short
RS6196	TMA/FC Hex Torque Driver - Long
RS6194	TMA/FC Hex Handpiece Adapter - Short

RS6195A	TMA/FC Hex Handpiece Adapter - Long
RP0005	Star Torque Driver - Long
RP0065	Star Torque Driver - Short
RP0019	Star Handpiece Driver - Long
RP0018	Star Handpiece Driver - Short
RP0004	Star Hand Driver - Long
RP0064	Star Hand Driver - Short
RS6090	Torque Driver for Ball Attachment
NP0014	NP Retrieval Screw for Abutments
RP3401	RP Retrieval Screw for Abutments
WP3401	WP Retrieval Screw for Abutments
RS3401	RS Retrieval Screw for Abutments
PK6303	Prosthetic Kit Tray

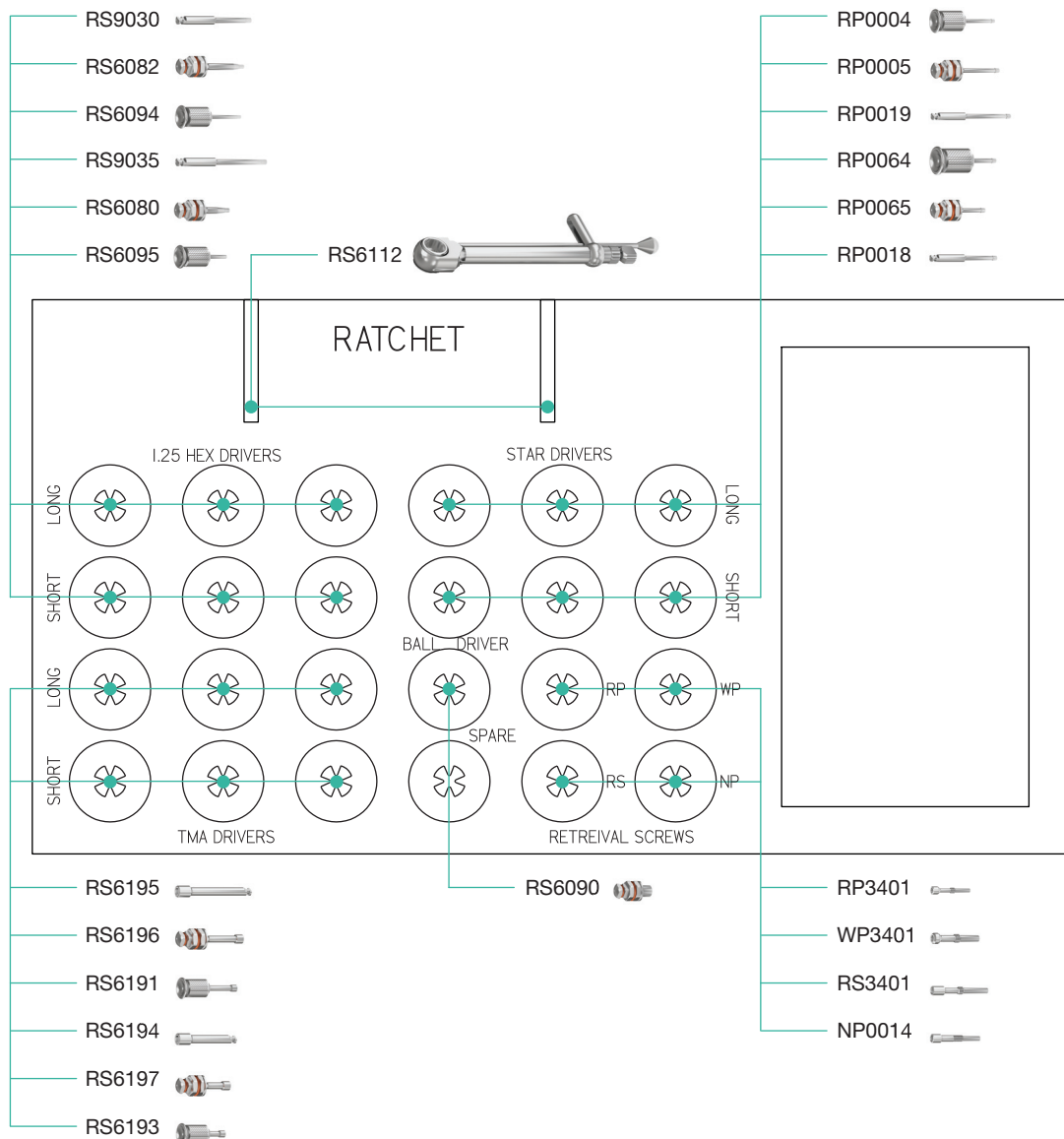



Long DLC Two Step Drills

	DL1820	Pilot Drill 2mmD x 8-18mmL White	White	Stainless Steel & DLC
	DL1828	Twist Step Drill 2.3/2.8mmD x 8-18mmL	Red	Stainless Steel & DLC
	DL1832	Twist Step Drill 2.8/3.2mmD x 8-18mmL	Blue	Stainless Steel & DLC
	DL1836	Twist Step Drill 3.2/3.6mmD x 8-18mmL	Green	Stainless Steel & DLC
	DL1842	Twist Step Drill 3.8/4.2mmD x 8-18mmL	Black	Stainless Steel & DLC
	DL1846	Twist Step Drill 4.2/4.6mmD x 8-18mmL	Yellow	Stainless Steel & DLC
	DL1852	Twist Step Drill 4.8/5.2mmD x 8-18mmL	Brown	Stainless Steel & DLC
	DL1856	Twist Step Drill 5.2/5.6mmD x 8-18mmL	Grey	Stainless Steel & DLC

Short DLC Two Step Drills

	DL1320	Pilot Drill 2mmD x 3-13mmL	White	Stainless Steel & DLC
	DL1328	Twist Step Drill 2.3/2.8mmD x 6-13mmL	Red	Stainless Steel & DLC
	DL1332	Twist Step Drill 2.8/3.2mmD x 6-13mmL	Blue	Stainless Steel & DLC
	DL1336	Twist Step Drill 3.2/3.6mmD x 6-13mmL	Green	Stainless Steel & DLC
	DL1342	Twist Step Drill 3.8/4.2mmD x 6-13mmL	Black	Stainless Steel & DLC
	DL1346	Twist Step Drill 4.2/4.6mmD x 6-13mmL	Yellow	Stainless Steel & DLC
	DL1352	Twist Step Drill 4.8/5.2mmD x 6-13mmL	Brown	Stainless Steel & DLC
	DL1356	Twist Step Drill 5.2/5.6mmD x 6-13mmL	Grey	Stainless Steel & DLC

Three Step DLC Drills

	TD1511	Three Step Drill-Short	Stainless Steel
	TD2218	Three Step Drill-Long	Stainless Steel

Tip Drill

	RS8032	Tip Drill	Stainless Steel
---	--------	-----------	-----------------

Drill Extension

	RS9027	Drill Extension	Stainless Steel
---	--------	-----------------	-----------------

## Tools

RS6111



Surgical Torque Ratchet 35-100 Ncm | Ti Grade 5

RS6112



Prosthetic Torque Ratchet 15-35 Ncm | Ti Grade 5

RS6100



Wrench Ratchet | Ti Grade 5

RS7001

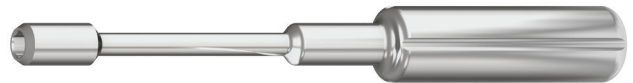

Surgical Driver | Ti Grade 5

RS6180



Depth Probe | Ti Grade 5

RS6150



Parallel Pin 11  
| stainless steel

RS6155



Parallel Pin 16  
| stainless steel

## Osteotomes

HA1000

Osteotome Kit including: HA0074, HA0061, HA0064, HA0067, HA0070

HA0074



Osteotome Handle | Aluminium + Stainless Steel

HA0061



Osteotome Insert 2.0mmD | Ti Grade 5

HA0067



Osteotome Insert 3.25mmD | Ti Grade 5

HA0064



Osteotome Insert 2.8mmD | Ti Grade 5

HA0070



Osteotome Insert 3.65mmD | Ti Grade 5



Touareg CloseFit™ NP / RP / WP Surgical Tools

	NP0006	NP 2mm Torque Driver - Short	Stainless Steel
	NP0005	NP 2mm Torque Driver - Long	Stainless Steel
	NP0062	NP 2mm Hex Handpiece Adapter - Short	Stainless Steel
	NP0072	NP 2mm Hex Handpiece Adapter - Long	Stainless Steel
	RP0067	RP 2.2mm Hex Torque Driver - Short	Stainless Steel
	RP0066	RP 2.2mm Hex Torque Driver - Long	Stainless Steel
	RP0062	RP Handpiece Hex Adapter - Short	Stainless Steel
	RP0072	RP Handpiece Hex Adapter - Long	Stainless Steel
	WP0066	WP 2.6mm Torque Driver - Long	Stainless Steel
	WP0067	WP 2.6mm Torque Driver - Short	Stainless Steel
	WP0062	WP Handpiece Hex Adapter - Short	Stainless Steel
	WP0072	WP Handpiece Hex Adapter - Long	Stainless Steel















Touareg CloseFit™ NP / RP / WP Prosthetic Tools

	RP0064	Star Hand Driver - Short	Stainless Steel
	RP0004	Star Hand Driver - Long	Stainless Steel
	RP0065	Star Torque Driver - Short	Stainless Steel
	RP0005	Star Torque Driver - Long	Stainless Steel
	RP0018	Star Handpiece Driver - Short	Stainless Steel
	RP0019	Star Handpiece Driver - Long	Stainless Steel
	RS6090	Torque Driver for Ball Attachment	Stainless Steel
	RS6194	TMA/ FC Hex Handpiece Adapter - Short	Stainless Steel
	RS6195A	TMA/ FC Hex Handpiece Adapter - Long	Stainless Steel
	RS6197	TMA/FC Hex Torque Driver - Short	Stainless Steel
	RS6196	TMA/FC Hex Torque Driver - Long	Stainless Steel
	RS6193	TMA/ FC Female Hand Hex Driver - Short	Stainless Steel
	RS6191	TMA/ FC Female Hand Hex Driver - Long	Stainless Steel

## Standard Internal Hex Surgical Tools

	RS6011	RS 2.4 Hex Torque Driver - Short	Stainless Steel
	RS6012	RS 2.4 Hex Torque Driver - Long	Stainless Steel
	RS9020	RS Hex Handpiece Adapter - Short	Stainless Steel
	RS9025	RS Hex Handpiece Adapter - Long	Stainless Steel
	RS9021	RS Hex Handpiece Adapter - Short	Stainless Steel
	RS9026	RS Hex Handpiece Adapter - Medium	Stainless Steel
	RS9029	RS Hex Handpiece Adapter - Long	Stainless Steel
	RA0040	Torque Ratchet Surgical Instruments Handle	Stainless Steel
	RA0050	Wrench Ratchet Surgical Instruments Handle	Stainless Steel
	RS6026	RS One Piece Torque Driver - Long	Stainless Steel

## Standard Internal Hex Prosthetic Tools

	RS6080	1.27 Hex Torque Driver - Short	Stainless Steel
	RS6082	1.27 Hex Torque Driver - Long	Stainless Steel
	RS9030	1.27 Hex Driver for Handpiece - Short	Stainless Steel
	RS9035	1.27 Hex Driver for Handpiece - Long	Stainless Steel
	RS6094	1.27 Hex Hand Driver - Medium	Stainless Steel
	RS6095	1.27 Hex Hand Driver - Short	Stainless Steel
	RS6097	1.27 Hex Hand Driver - Long	Stainless Steel
	RS6090	Torque Driver for Ball Attachment	Stainless Steel
	RS6194	TMA/FC Hex Handpiece Adapter - Short	Stainless Steel
	RS6195A	TMA/FC Hex Handpiece Adapter - Long	Stainless Steel
	RS6197	TMA/FC Hex Torque Driver - Short	Stainless Steel
	RS6196	TMA/FC Hex Torque Driver - Long	Stainless Steel
	RS6193	TMA / FC Female Hand Hex Driver - Short	Stainless Steel
	RS6191	TMA / FC Female Hand Hex Driver - Long	Stainless Steel

## Index in Alphabetical Order

Catalog No.	Description	Page No.	Catalog No.	Description	Page No.
RS9035	1.27 Hex Driver for Handpiece - Long	48,60,64	NP0012	NP Healing Abutment 4.5mmD x 5mmL	11
RS9030	1.27 Hex Driver for Handpiece - Short	48,60,64	NP0013	NP Healing Abutment 4.5mmD x 6mmL	11
RS6097	1.27 Hex Hand Driver - Long	48	NP0007	NP Implant Analog	14
RS6094	1.27 Hex Hand Driver - Medium	48,58,59,60,64	NP0002	NP Implant Cover Screw	14
RS6095	1.27 Hex Hand Driver - Short	48,58,59,60,64	NP0044	NP Non Engaging Temporary Abutment	11
RS6082	1.27 Hex Torque Driver - Long	48,58,59,60,64	NP3097	NP Non-Engaging Titanium / Plastic Abutment	12
RS6080	1.27 Hex Torque Driver - Short	48,58,59,60,64	NP0017	NP Open Tray Transfer	14
	<b>B</b>		NP0028	NP Open Tray Transfer Screw	14
RS5740	Ball Attachment Abutment Replica	14,19,25,49	NP0045	NP Plastic Cylinder Abutment	11
	<b>D</b>		NP0042	NP Retaining Screw for Angled TMA	14
RS6180	Depth Probe	56,57,58,59	NP0039	NP Retaining Screw for TMA 1mm	14
RS9027	Drill Extension	56,57,58,59,61	NP0040	NP Retaining Screw for TMA 2mm	14
	<b>F</b>		NP0041	NP Retaining Screw for TMA 3mm	14
FC4502	Flat Connection Abutment 2mm	47	NP3409	NP retaining Screw for TMA 4mm	14
FC4504	Flat Connection Abutment 4mm	47	NP3412	NP Retaining Screw for TMA 5mm	14
FC6011	Flat Connection Castable Abutment for Centering Ring	12,17,23,47	NP0014	NP Retrieval Screw for Abutments	14,60
FC6018	Flat Connection Centering Ring	13,18,24,47	ZA0101	NP Screw For Zirconia Abutment	14
FC5737	Flat Connection Implant Replica	12,17,23,47	NP0016	NP Slim Closed Tray Transfer	14
FC6017	Flat Connection Long Laboratory Screw	13,17,24,47	NP0046	NP Slim Healing Abutment 3mmD x 2mmL	11
FC5515	Flat Connection Temporary Cylinder Sleeve	12,17,23,47	NP0047	NP Slim Healing Abutment 3mmD x 3mmL	11
FC6013	Flat Connection Titanium Gluing Ring	13,17,23,47	NP0048	NP Slim Healing Abutment 3mmD x 4mmL	11
FC6015	Flat Connection Titanium Retaining Screw	13,17,23,47	NP0049	NP Slim Healing Abutment 3mmD x 5mmL	11
FC5512	Flat Connection Transfer Impression Coping	13,18,24,47	NP0050	NP Slim Healing Abutment 3mmD x 6mmL	11
	<b>N</b>		NP0019	NP Straight Abutment 1mm	11
NP0072	NP 2mm Hex Handpiece Adapter - Long	14,56,57	NP0011	NP Straight Abutment 2mm	11
NP0062	NP 2mm Hex Handpiece Adapter - Short	14,56,57	NP0064	NP Straight Abutment 3mm	11
NP0005	NP 2mm Torque Driver - Long	13,56,57,63	NP0010	NP Straight Slim Abutment - No End Line	11
NP0006	NP 2mm Torque Driver - Short	13,56,57,63	ZA0105	NP Straight Zirconium Abutment w/ Titanium Base	12
NP0001	NP Abutment Screw	14	NP0032	NP Straight Trans Mucosal Abutment 1mm	12
NP0035	NP Angled Trans Mucosal Abutment 17° L=3mm	12	NP0033	NP Straight Trans Mucosal Abutment 2mm	12
NP0038	NP Angled Trans Mucosal Abutment 17° L=4mm	12	NP0034	NP Straight Trans Mucosal Abutment 3mm	12
NP0036	NP Angled Trans Mucosal Abutment 30° L=3.5mm	12	NP3729	NP Straight Trans Mucosal Abutment 4mm	12
NP0037	NP Angled Trans Mucosal Abutment 30° L=5mm	12	NP3730	NP Straight Trans Mucosal Abutment 5mm	12
ZA0107	NP Angled Zirconium Abutment 15° w/ Titanium Base	12		<b>O</b>	
NP0020	NP Ball Attachment 0.5mm	13	IO1030	One™ Dental Implant 3.0D 10L	50,51
NP0021	NP Ball Attachment 1mm	13	IO1130	One™ Dental Implant 3.0D 11.5L	50,51
NP0022	NP Ball Attachment 2mm	13	IO1330	One™ Dental Implant 3.0D 13L	50,51
NP0023	NP Ball Attachment 3mm	13	IO1530	One™ Dental Implant 3.0D 15L	50,51
NP0024	NP Ball Attachment 4mm	13	IO1033	One™ Dental Implant 3.3D 10L	50,52
NP0027	NP Closed Tray Transfer Screw	14	IO1133	One™ Dental Implant 3.3D 11.5L	50,52
NP0015	NP Closefit Angled Abutment 15° 1mm	11	IO1333	One™ Dental Implant 3.3D 13L	50,52
NP0018	NP CloseFit™ Angled Abutment 15° - No End Line	11	IO1533	One™ Dental Implant 3.3D 15L	50,52
NP0026	NP CloseFit™ Angled Abutment 15° 2mm	11	IO1036	One™ Dental Implant 3.6D 10L	50,53
NP0063	NP CloseFit™ Angled Abutment 15° 3mm	11	IO1136	One™ Dental Implant 3.6D 11.5L	50,53
NP0090	NP Conical Healing Abutment 4.5mmD x 2mmL	11	IO1336	One™ Dental Implant 3.6D 13L	50,53
NP0091	NP Conical Healing Abutment 4.5mmD x 3mmL	11	IO1536	One™ Dental Implant 3.6D 15L	50,53
NP0092	NP Conical Healing Abutment 4.5mmD x 4mmL	11	IO1042	One™ Dental Implant 4.2D 10L	50,54
NP0093	NP Conical Healing Abutment 4.5mmD x 5mmL	11	IO1142	One™ Dental Implant 4.2D 11.5L	50,54
NP0094	NP Conical Healing Abutment 4.5mmD x 6mmL	11	IO1342	One™ Dental Implant 4.2D 13L	50,54
NP0043	NP Engaging Temporary Abutment	11	IO1542	One™ Dental Implant 4.2D 15L	50,54
NP3095	NP Engaging Titanium / Plastic Abutment	12	IO1050	One™ Dental Implant 5.0D 10L	50,55
NP0030	NP Flat Connection Abutment 2mm	12	IO1150	One™ Dental Implant 5.0D 11.5L	50,55
NP0031	NP Flat Connection Abutment 4mm	12	IO1350	One™ Dental Implant 5.0D 13L	50,55
NP0004	NP Healing Abutment 4.5mmD x 2mmL	11	IO1550	One™ Dental Implant 5.0D 15L	50,55
NP0008	NP Healing Abutment 4.5mmD x 3mmL	11	HA0061	Osteotome insert 2.0mmD	62
NP0009	NP Healing Abutment 4.5mmD x 4mmL	11	HA0064	Osteotome insert 2.8mmD	62
			HA0067	Osteotome insert 3.25mmD	62
			HA0070	Osteotome insert 3.65mmD	62
			HA1000	Osteotome Kit	62

# 66 | Index in Alphabetical Order

Catalog No.	Description	Page No.	Catalog No.	Description	Page No.
<b>P</b>					
RS6150	Parallel Pin 11	56,57,58,59,62	RP0046	RP Slim Healing Abutment 3.5mmD x 2mmL	16
RS6155	Parallel Pin 16	56,57,58,59,62	RP0047	RP Slim Healing Abutment 3.5mmD x 3mmL	16
DL1320	Pilot Drill 2mmD x 6-13mmL	57,59,61	RP0048	RP Slim Healing Abutment 3.5mmD x 4mmL	16
DL1820	Pilot Drill 2mmD x 8-18mmL	56,57,58,59,61	RP0049	RP Slim Healing Abutment 3.5mmD x 5mmL	16
RS2662	Plastic Ball Cap Pink Soft	13,18,24,48	RP0050	RP Slim Healing Abutment 3.5mmD x 6mmL	16
RS2660	Plastic Ball Cap White	13,18,24,48	RP0012	RP Straight Abutment 1mm	16
PK6300	Prosthetic Kit Metal	60	RP0011	RP Straight Abutment 2mm	16
PK6303	Prosthetic Kit Tray	60	RP0010	RP Straight Abutment 3mm	16
RS6112	Prosthetic Torque Ratchet 15-35 Ncm	60,62	RP0020	RP Straight Slim Abutment - No End Line	16
<b>R</b>					
RP0066	RP 2.2mm Torque Driver - Long	18,56,57,63	RP0032	RP Straight Trans Mucosal Abutment 1mm	17
RP0067	RP 2.2mm Torque Driver - Short	18,56,57,63	RP0033	RP Straight Trans Mucosal Abutment 2mm	17
RP0001	RP Abutment Screw	19	RP0034	RP Straight Trans Mucosal Abutment 3mm	17
RP0013	RP Angled Abutment 15° 1mm	16	RP3729	RP Straight Trans Mucosal Abutment 4 mm	17
RP0014	RP Angled Abutment 15° 2mm	16	RP3730	RP Straight Trans Mucosal Abutment 5 mm	17
RP0015	RP Angled Abutment 15° 3mm	16	ZA0214	RP Straight Zirconium Abutment w/ Titanium Base	17
RP3734	RP Angled Trans Mucosal Abutment 17° 2.5mm	17	RS6322	RS - Standard Internal Hex Plastic Surgical Kit - Advanced	58
RP3737	RP Angled Trans Mucosal Abutment 17° 3.5mm	17	RS6301	RS - Standard Internal Hex Plastic Surgical Kit - Premium	58
RP3735	RP Angled Trans Mucosal Abutment 30° 3mm	17	RS6333	RS - Standard Internal Hex Plastic Surgical Kit - Starter	58
RP3738	RP Angled Trans Mucosal Abutment 30° 4mm	17	RS6012	RS 2.4 Hex Torque Driver - Long	48,64
ZA0207	RP Angled Zirconium Abutment 15° w/ Titanium Base	17	RS6011	RS 2.4 Hex Torque Driver - Short	48,64
RP0051	RP Ball Attachment 0.5mm	18	RS4015	RS Angled Titanium Abutment 15°	45
RP0052	RP Ball Attachment 1mm	18	RS4016	RS Angled Titanium Abutment 15° Long	45
RP0053	RP Ball Attachment 2mm	18	RS4025	RS Angled Titanium Abutment 25°	45
RP0054	RP Ball Attachment 3mm	18	RS4035	RS Angled Titanium Abutment 35°	45
RP0055	RP Ball Attachment 4mm	18	RS3734	RS Angled Trans Mucosal Abutment 17° 2mm	46
RP0056	RP Ball Attachment 5mm	18	RS3737	RS Angled Trans Mucosal Abutment 17° 3mm	46
RP0027	RP Closed Tray Transfer Screw	19	RS3735	RS Angled Trans Mucosal Abutment 30° 3mm	46
RP0090	RP Conical Healing Abutment 4.5mmD x 2mmL	16	RS3738	RS Angled Trans Mucosal Abutment 30° 4mm	46
RP0091	RP Conical Healing Abutment 4.5mmD x 3mmL	16	RS3736	RS Angled Trans Mucosal Abutment 45° 4mm	46
RP0092	RP Conical Healing Abutment 4.5mmD x 4mmL	16	ZA0007	RS Angled Zirconium Abutment 15° w/ Titanium Base	46
RP0093	RP Conical Healing Abutment 4.5mmD x 5mmL	16	ZA1015	RS Angled Zirconium Abutment w/ Titanium Base 1mm	46
RP0094	RP Conical Healing Abutment 4.5mmD x 6mmL	16	ZA1016	RS Angled Zirconium Abutment w/ Titanium Base 2mm	46
RP0043	RP Engaging Temporary Abutment	16	ZA1017	RS Angled Zirconium Abutment w/ Titanium Base 3mm	46
RP3095	RP Engaging Titanium / Plastic Abutment	16	ZA1018	RS Angled Zirconium Abutment w/ Titanium Base 4mm	46
RP0030	RP Flat Connection Abutment 2mm	17	ZA1019	RS Angled Zirconium Abutment w/ Titanium Base 5mm	46
RP0031	RP Flat Connection Abutment 4mm	17	RS2650	RS Ball Attachment 0.5mm	47
RP0072	RP Handpiece Hex Adapter - Long	19,56,57	RS2651	RS Ball Attachment 1mm	47
RP0062	RP Handpiece Hex Adapter - Short	19,56,57	RS2861	RS Ball Attachment 1mm w/Hex	47
RP0022	RP Healing Abutment 4.5mmD x 2mmL	16	RS2652	RS Ball Attachment 2mm	47
RP0023	RP Healing Abutment 4.5mmD x 3mmL	16	RS2862	RS Ball Attachment 2mm w/Hex	47
RP0024	RP Healing Abutment 4.5mmD x 4mmL	16	RS2653	RS Ball Attachment 3mm	47
RP0025	RP Healing Abutment 4.5mmD x 5mmL	16	RS2863	RS Ball Attachment 3mm w/Hex	47
RP0026	RP Healing Abutment 4.5mmD x 6mmL	16	RS2654	RS Ball Attachment 4mm	47
RP0007	RP Implant Analog	19	RS2864	RS Ball Attachment 4mm w/Hex	47
RP0021	RP Implant Cover Screw	19	RS2655	RS Ball Attachment 5mm	47
RP0044	RP Non-Engaging Temporary Abutment	16	RS2865	RS Ball Attachment 5mm w/Hex	47
RP3097	RP Non-Engaging Titanium / Plastic Abutment	16	RS2866	RS Ball Attachment 6mm w/Hex	47
RP0017	RP Open Tray Transfer	19	RS5512	RS Closed Tray Transfer 12mm	49
RP0028	RP Open Tray Transfer Screw	19	RS5509	RS Closed Tray Transfer 9mm	49
RP0045	RP Plastic Cylinder Abutment	16	RS3090	RS Engaging Gold / Plastic Abutment	45
RP3403	RP Retaining Screw for Angled TMA	19	RS5010	RS Engaging Plastic Casting Standard Abutment	45
RP0039	RP Retaining Screw For TMA 1mm	19	RS5040	RS Engaging Plastic Cylinder Abutment	45
RP0040	RP Retaining Screw For TMA 2mm	19	RS5000	RS Engaging Plastic Cylinder Casting Abutment	45
RP0041	RP Retaining Screw For TMA 3mm	19	RS5030	RS Engaging Plastic Standard Abutment	45
RP3409	RP Retaining Screw for TMA 4mm	19	RS3095	RS Engaging Titanium / Plastic Abutment	45
RP3412	RP Retaining Screw for TMA 5mm	19	RS4115	RS Esthetic Angled Titanium Abutment 15° 1mm	45
RP3401	RP Retrieval Screw for Abutments	19,60	RS4117	RS Esthetic Angled Titanium Abutment 15° 2mm	45
ZA0201	RP Screw For Zirconia Abutment	19	RS4119	RS Esthetic Angled Titanium Abutment 15° 3mm	45
RP0016	RP Slim Closed Tray Transfer	19	RS3022	RS Healing Abutment 4.5mmD x 2mmL	44
			RS3023	RS Healing Abutment 4.5mmD x 3mmL	44
			RS3024	RS Healing Abutment 4.5mmD x 4mmL	44
			RS3025	RS Healing Abutment 4.5mmD x 5mmL	44





# 68 | Index in Alphabetical Order

Catalog No.	Description	Page No.	Catalog No.	Description	Page No.
RS5005	TMA Healing Cap	12,17,23,46	ISF1360	Touareg™-OS Dental Implant 6.0D 13L	26,32
RS5006	TMA Impression Coping Open Tray	12,17,28,47	ISF0660	Touareg™-OS Dental Implant 6.0D 6.25L	26,32
RS5001	TMA Plastic Casting Sleeve w/Prosthetic Screw	12,17,23,46	ISF0860	Touareg™-OS Dental Implant 6.0D 8L	26,32
RS3404	TMA Prosthetic Screw	49	ISPS1035	Touareg™-S Dental Implant 3.5D 10L	26,33
RS5008	TMA Screw For Open Tray Impression Copying	49	ISPS1135	Touareg™-S Dental Implant 3.5D 11.5L	26,33
RS4900	TMA Titanium Temporary Copying	12,17,23,46	ISPS1335	Touareg™-S Dental Implant 3.5D 13L	26,33
RS6090	Torque Driver for Ball Attachment	13,18,24,48,60,63,64	ISPS1635	Touareg™-S Dental Implant 3.5D 16L	26,33
RA0040	Torque Ratchet Surgical Instruments Handle	58,59,64	ISPS1835	Touareg™-S Dental Implant 3.5D 18L	26,33
CF6302	Touareg CloseFit™ Plastic Surgical Kit - Advanced	56	ISPS0835	Touareg™-S Dental Implant 3.5D 8L	33
CF6300	Touareg CloseFit™ Plastic Surgical Kit - Premium	56	ISPS1038	Touareg™-S Dental Implant 3.75D 10L	26,34
CF6303	Touareg CloseFit™ Plastic Surgical Kit - Starter	56	ISPS1138	Touareg™-S Dental Implant 3.75D 11.5L	26,34
ISPX1035	Touareg CloseFit™ RP Dental Implant 3.5D 10L	8,15	ISPS1338	Touareg™-S Dental Implant 3.75D 13L	26,34
ISPX1135	Touareg CloseFit™ RP Dental Implant 3.5D 11.5L	8,15	ISPS1638	Touareg™-S Dental Implant 3.75D 16L	26,34
ISPX1335	Touareg CloseFit™ RP Dental Implant 3.5D 13L	8,15	ISPS1838	Touareg™-S Dental Implant 3.75D 18L	26,34
ISPX1535	Touareg CloseFit™ RP Dental Implant 3.5D 15L	8,15	ISPS0838	Touareg™-S Dental Implant 3.75D 8L	26,34
ISPX1835	Touareg CloseFit™ RP Dental Implant 3.5D 18L	8,15	ISPS1042	Touareg™-S Dental Implant 4.2D 10L	26,35
ISPX0835	Touareg CloseFit™ RP Dental Implant 3.5D 8.0L	8,15	ISPS1142	Touareg™-S Dental Implant 4.2D 11.5L	26,35
CF6301	Touareg CloseFit™ Surgical Tray	56	ISPS1342	Touareg™-S Dental Implant 4.2D 13L	26,35
ISPX1043	Touareg CloseFit™ WP Dental Implant 4.3D 10L	8,20	ISPS1642	Touareg™-S Dental Implant 4.2D 16L	26,35
ISPX1143	Touareg CloseFit™ WP Dental Implant 4.3D 11.5L	8,20	ISPS1842	Touareg™-S Dental Implant 4.2D 18L	26,35
ISPX1543	Touareg CloseFit™ WP Dental Implant 4.3D 15L	8,20	ISPS0642	Touareg™-S Dental Implant 4.2D 6.25L	26,35
ISPX1843	Touareg CloseFit™ WP Dental Implant 4.3D 18L	8,20	ISPS0842	Touareg™-S Dental Implant 4.2D 8L	26,35
ISPX0843	Touareg CloseFit™ WP Dental Implant 4.3D 8.0L	8,20	ISPS1050	Touareg™-S Dental Implant 5.0D 10L	26,36
ISPX1049	Touareg CloseFit™ WP Dental Implant 5D 10L	8,21	ISPS1150	Touareg™-S Dental Implant 5.0D 11.5L	26,36
ISPX1149	Touareg CloseFit™ WP Dental Implant 5D 11.5L	8,21	ISPS1350	Touareg™-S Dental Implant 5.0D 13L	26,36
ISPX1349	Touareg CloseFit™ WP Dental Implant 5D 13L	8,21	ISPS1650	Touareg™-S Dental Implant 5.0D 16L	26,36
ISPX1549	Touareg CloseFit™ WP Dental Implant 5D 15L	8,21	ISPS0650	Touareg™-S Dental Implant 5.0D 6.25L	26,36
ISPX1849	Touareg CloseFit™ WP Dental Implant 5D 18L	8,21	ISPS0850	Touareg™-S Dental Implant 5.0D 8L	26,36
ISPX0849	Touareg CloseFit™ WP Dental Implant 5D 8.0L	8,21	ISPS1060	Touareg™-S Dental Implant 6.0D 10L	26,37
ISPX1343	Touareg CloseFit™ WP Dental Implant 4.3D 13L	8,20	ISPS1160	Touareg™-S Dental Implant 6.0D 11.5L	26,37
ISPNP1030	Touareg™-NP Dental Implant 3.0D 10L	8,10	ISPS1360	Touareg™-S Dental Implant 6.0D 13L	26,37
ISPNP1130	Touareg™-NP Dental Implant 3.0D 11.5L	8,10	ISPS0660	Touareg™-S Dental Implant 6.0D 6.25L	26,37
ISPNP1330	Touareg™-NP Dental Implant 3.0D 13L	8,10	ISPS0860	Touareg™-S Dental Implant 6.0D 8L	26,37
ISPNP1630	Touareg™-NP Dental Implant 3.0D 16L	8,10	DL1328	Twist Step Drill 2.3/2.8mmD x 6-13mmL	57,59,61
ISPNP1830	Touareg™-NP Dental Implant 3.0D 18L	8,10	DL1828	Twist Step Drill 2.3/2.8mmD x 8-18mmL	56,57,58,59,61
ISF1035	Touareg™-OS Dental Implant 3.5D 10L	26,28	DL1332	Twist Step Drill 2.8/3.2mmD x 6-13mmL	57,59,61
ISF1135	Touareg™-OS Dental Implant 3.5D 11.5L	26,28	DL1832	Twist Step Drill 2.8/3.2mmD x 8-18mmL	56,57,58,59,61
ISF1335	Touareg™-OS Dental Implant 3.5D 13L	26,28	DL1336	Twist Step Drill 3.2/3.6mmD x 6-13mmL	57,59,61
ISF1635	Touareg™-OS Dental Implant 3.5D 16L	26,28	DL1836	Twist Step Drill 3.2/3.6mmD x 8-18mmL	56,57,58,61
ISF1835	Touareg™-OS Dental Implant 3.5D 18L	26,28	DL1342	Twist Step Drill 3.8/4.2mmD x 6-13mmL	57,59,61
ISF0835	Touareg™-OS Dental Implant 3.5D 8L	26,28	DL1842	Twist Step Drill 3.8/4.2mmD x 8-18mmL	56,57,58,59,61
ISF1038	Touareg™-OS Dental Implant 3.75D 10L	26,29	DL1346	Twist Step Drill 4.2/4.6mmD x 6-13mmL	57,59,61
ISF1138	Touareg™-OS Dental Implant 3.75D 11.5L	26,29	DL1846	Twist Step Drill 4.2/4.6mmD x 8-18mmL	56,57,58,59,61
ISF1338	Touareg™-OS Dental Implant 3.75D 13L	26,29	DL1352	Twist Step Drill 4.8/5.2mmD x 6-13mmL	61
ISF1638	Touareg™-OS Dental Implant 3.75D 16L	26,29	DL1852	Twist Step Drill 4.8/5.2mmD x 8-18mmL	58,59,61
ISF1838	Touareg™-OS Dental Implant 3.75D 18L	26,29	DL1356	Twist Step Drill 5.2/5.6mmD x 6-13mmL	59,61
ISF0838	Touareg™-OS Dental Implant 3.75D 8L	26,29	DL1856	Twist Step Drill 5.2/5.6mmD x 8-18mmL	58,59,61
ISF1042	Touareg™-OS Dental Implant 4.2D 10L	26,30			
ISF1142	Touareg™-OS Dental Implant 4.2D 11.5L	26,30			
ISF1342	Touareg™-OS Dental Implant 4.2D 13L	26,30	WP0066	WP 2.6mm Torque Driver - Long	24,56,57,63
ISF1642	Touareg™-OS Dental Implant 4.2D 16L	26,30	WP0067	WP 2.6mm Torque Driver - Short	24,56,57,63
ISF1842	Touareg™-OS Dental Implant 4.2D 18L	26,30	WP0001	WP Abutment Screw	25
ISF0642	Touareg™-OS Dental Implant 4.2D 6.25L	26,30	WP0013	WP Angled Abutment 15° 1mm	22
ISF0842	Touareg™-OS Dental Implant 4.2D 8L	26,30	WP0014	WP Angled Abutment 15° 2mm	22
ISF1050	Touareg™-OS Dental Implant 5.0D 10L	26,31	WP0015	WP Angled Abutment 15° 3mm	22
ISF1150	Touareg™-OS Dental Implant 5.0D 11.5L	26,31	WP3734	WP Angled Trans Mucosal Abutment 17° 2.5mm	23
ISF1350	Touareg™-OS Dental Implant 5.0D 13L	26,31	WP3737	WP Angled Trans Mucosal Abutment 17° 3.5mm	23
ISF1650	Touareg™-OS Dental Implant 5.0D 16L	26,31	WP3735	WP Angled Trans Mucosal Abutment 30° 3mm	23
ISF0650	Touareg™-OS Dental Implant 5.0D 6.25L	26,31	WP3738	WP Angled Trans Mucosal Abutment 30° 4mm	23
ISF0850	Touareg™-OS Dental Implant 5.0D 8L	26,31	ZA0307	WP Angled Zirconium Abutment 15° w/ Titanium Base	23
ISF1060	Touareg™-OS Dental Implant 6.0D 10L	26,32	WP0051	WP Ball Attachment 0.5mm	24
ISF1160	Touareg™-OS Dental Implant 6.0D 11.5L	26,32	WP0052	WP Ball Attachment 1mm	24

Catalog No.	Description	Page No.	Catalog No.	Description	Page No.
WP0053	WP Ball Attachment 2mm	24	WP0045	WP Plastic Cylinder Abutment	22
WP0054	WP Ball Attachment 3mm	24	WP3403	WP Retaining Screw for Angled TMA	25
WP0055	WP Ball Attachment 4mm	24	WP3406	WP Retaining Screw for TMA 1mm	25
WP0056	WP Ball Attachment 5mm	24	WP3407	WP Retaining Screw for TMA 2mm	25
WP0027	WP Closed Tray Transfer Screw	25	WP3408	WP Retaining Screw for TMA 3mm	25
WP0090	WP Conical Healing Abutment 5.5mmD x 2mmL	22	WP3409	WP Retaining Screw for TMA 4mm	25
WP0091	WP Conical Healing Abutment 5.5mmD x 3mmL	22	WP3412	WP Retaining Screw for TMA 5mm	25
WP0092	WP Conical Healing Abutment 5.5mmD x 4mmL	22	WP3401	WP Retrieval Screw for Abutments	25,60
WP0093	WP Conical Healing Abutment 5.5mmD x 5mmL	22	ZA0301	WP Screw for Zirconia Abutment	25
WP0094	WP Conical Healing Abutment 5.5mmD x 6mmL	22	WP0016	WP Slim Closed Tray Transfer	25
WP0043	WP Engaging Temporary Abutment	22	WP0046	WP Slim Healing Abutment 4mmD x 2mmL	22
WP3095	WP Engaging Titanium / Plastic Abutment	22	WP0047	WP Slim Healing Abutment 4mmD x 3mmL	22
WP0030	WP Flat Connection Abutment 2mm	23	WP0048	WP Slim Healing Abutment 4mmD x 4mmL	22
WP0031	WP Flat Connection Abutment 4mm	23	WP0049	WP Slim Healing Abutment 4mmD x 5mmL	22
WP0072	WP Handpiece Hex Adapter - Long	25,56,57	WP0050	WP Slim Healing Abutment 4mmD x 6mmL	22
WP0062	WP Handpiece Hex Adapter - Short	25,56,57	WP0012	WP Straight Abutment 1mm	22
WP0022	WP Healing Abutment 5.5mmD x 2mmL	22	WP0011	WP Straight Abutment 2mm	22
WP0023	WP Healing Abutment 5.5mmD x 3mmL	22	WP0010	WP Straight Abutment 3mm	22
WP0024	WP Healing Abutment 5.5mmD x 4mmL	22	WP0020	WP Straight Slim Abutment - No End Line	22
WP0025	WP Healing Abutment 5.5mmD x 5mmL	22	WP3731	WP Straight Trans Mucosal Abutment 1mm	23
WP0026	WP Healing Abutment 5.5mmD x 6mmL	22	WP3732	WP Straight Trans Mucosal Abutment 2mm	23
WP0007	WP Implant Analog	25	WP3733	WP Straight Trans Mucosal Abutment 3mm	23
WP0021	WP Implant Cover Screw	25	WP3729	WP Straight Trans Mucosal Abutment 4mm	23
WP0044	WP Non-Engaging Temporary Abutment	22	WP3730	WP Straight Trans Mucosal Abutment 5mm	23
WP3097	WP Non-Engaging Titanium / Plastic Abutment	22	ZA0314	WP Straight Zirconium Abutment w/ Titanium Base	23
WP0017	WP Open Tray Transfer	25	RS6100	Wrench Ratchet	56,59,62
WP0028	WP Open Tray Transfer Screw	25	RA0050	Wrench Ratchet Surgical Instruments Handle	58,64

## Index in Numerical Order

Catalog No.	Description	Page No.	Catalog No.	Description	Page No.
CF6300	Touareg CloseFit™ Plastic Surgical Kit - Premium	56	FC5737	Flat Connection Implant Replica	12,17,23,47
CF6301	Touareg CloseFit™ Surgical Tray	56	FC6011	Flat Connection Castable Abutment for Centering Ring	12,17,23,47
CF6302	Touareg CloseFit™ Plastic Surgical Kit - Advanced	56	FC6013	Flat Connection Titanium Gluing Ring	13,17,23,47
CF6303	Touareg CloseFit™ Plastic Surgical Kit - Starter	56	FC6015	Flat Connection Titanium Retaining Screw	13,17,23,47
DL1320	Pilot Drill 2mmD x 6-13mmL	57,59,61	FC6017	Flat Connection Long Laboratory Screw	13,17,24,47
DL1328	Twist Step Drill 2.3/2.8mmD x 6-13mmL	57,59,61	FC6018	Flat Connection Centering Ring	13,18,24,47
DL1332	Twist Step Drill 2.8/3.2mmD x 6-13mmL	57,59,61	HA1000	Osteotome Kit	62
DL1336	Twist Step Drill 3.2/3.6mmD x 6-13mmL	57,59,61	HA0061	Osteotome insert 2.0mmD	62
DL1342	Twist Step Drill 3.8/4.2mmD x 6-13mmL	57,59,61	HA0064	Osteotome insert 2.8mmD	62
DL1346	Twist Step Drill 4.2/4.6mmD x 6-13mmL	57,59,61	HA0067	Osteotome insert 3.25mmD	62
DL1352	Twist Step Drill 4.8/5.2mmD x 6-13mmL	61	HA0070	Osteotome insert 3.65mmD	62
DL1356	Twist Step Drill 5.2/5.6mmD x 6-13mmL	59,61	ID0642	Swell™ Dental Implant 4.2D 6.25L	38,41
DL1820	Pilot Drill 2mmD x 8-18mmL	56,57,58,59,61	ID0650	Swell™ Dental Implant 5.0D 6.25L	38,42
DL1828	Twist Step Drill 2.3/2.8mmD x 8-18mmL	56,57,58,59,61	ID0660	Swell™ Dental Implant 6.0D 6.25L	38,43
DL1832	Twist Step Drill 2.8/3.2mmD x 8-18mmL	56,57,58,59,61	ID0838	Swell™ Dental Implant 3.75D 8L	38,40
DL1836	Twist Step Drill 3.2/3.6mmD x 8-18mmL	56,57,58,61	ID0842	Swell™ Dental Implant 4.2D 8L	38,41
DL1842	Twist Step Drill 3.8/4.2mmD x 8-18mmL	56,57,58,59,61	ID0850	Swell™ Dental Implant 5.0D 8L	38,42
DL1846	Twist Step Drill 4.2/4.6mmD x 8-18mmL	56,57,58,59,61	ID0860	Swell™ Dental Implant 6.0D 8L	38,43
DL1852	Twist Step Drill 4.8/5.2mmD x 8-18mmL	58,59,61	ID1033	Swell™ Dental Implant 3.3D 10L	38,39
DL1856	Twist Step Drill 5.2/5.6mmD x 8-18mmL	58,59,61	ID1038	Swell™ Dental Implant 3.75D 10L	38,40
FC4502	Flat Connection Abutment 2mm	47	ID1042	Swell™ Dental Implant 4.2D 10L	38,41
FC4504	Flat Connection Abutment 4mm	47	ID1050	Swell™ Dental Implant 5.0D 10L	38,42
FC5512	Flat Connection Transfer Impression Coping	13,18,24,47	ID1060	Swell™ Dental Implant 6.0D 10L	38,43
FC5515	Flat Connection Temporary Cylinder Sleeve	12,17,23,47	ID1133	Swell™ Dental Implant 3.3D 11.5L	38,39



# 70 | Index in Numerical Order

Catalog No.	Description	Page No.	Catalog No.	Description	Page No.
ID1138	Swell™ Dental Implant 3.75D 11.5L	38,40	ISF1650	Touareg™-OS Dental Implant 5.0D 16L	26,31
ID1142	Swell™ Dental Implant 4.2D 11.5L	38,41	ISF1835	Touareg™-OS Dental Implant 3.5D 18L	26,28
ID1150	Swell™ Dental Implant 5.0D 11.5L	38,42	ISF1838	Touareg™-OS Dental Implant 3.75D 18L	26,29
ID1160	Swell™ Dental Implant 6.0D 11.5L	38,43	ISF1842	Touareg™-OS Dental Implant 4.2D 18L	26,30
ID1333	Swell™ Dental Implant 3.3D 13L	38,39	ISPNP1030	Touareg™-NP Dental Implant 3.0D 10L	8,10
ID1338	Swell™ Dental Implant 3.75D 13L	38,40	ISPNP1130	Touareg™-NP Dental Implant 3.0D 11.5L	8,10
ID1342	Swell™ Dental Implant 4.2D 13L	38,41	ISPNP1330	Touareg™-NP Dental Implant 3.0D 13L	8,10
ID1350	Swell™ Dental Implant 5.0D 13L	38,42	ISPNP1630	Touareg™-NP Dental Implant 3.0D 16L	8,10
ID1360	Swell™ Dental Implant 6.0D 13L	38,43	ISPNP1830	Touareg™-NP Dental Implant 3.0D 18L	8,10
ID1633	Swell™ Dental Implant 3.3D 16L	38,39	ISPS0642	Touareg™-S Dental Implant 4.2D 6.25L	26,35
ID1638	Swell™ Dental Implant 3.75D 16L	38,40	ISPS0650	Touareg™-S Dental Implant 5.0D 6.25L	26,36
ID1642	Swell™ Dental Implant 4.2D 16L	38,41	ISPS0660	Touareg™-S Dental Implant 6.0D 6.25L	26,37
ID1650	Swell™ Dental Implant 5.0D 16L	38,42	ISPS0835	Touareg™-S Dental Implant 3.5D 8L	33
ID1833	Swell™ Dental Implant 3.3D 18L	38,39	ISPS0838	Touareg™-S Dental Implant 3.75D 8L	26,34
ID1838	Swell™ Dental Implant 3.75D 18L	38,40	ISPS0842	Touareg™-S Dental Implant 4.2D 8L	26,35
ID1842	Swell™ Dental Implant 4.2D 18L	38,41	ISPS0850	Touareg™-S Dental Implant 5.0D 8L	26,36
IO1030	One™ Dental Implant 3.0D 10L	50,51	ISPS0860	Touareg™-S Dental Implant 6.0D 8L	26,37
IO1033	One™ Dental Implant 3.3D 10L	50,52	ISPS1035	Touareg™-S Dental Implant 3.5D 10L	26,33
IO1036	One™ Dental Implant 3.6D 10L	50,53	ISPS1038	Touareg™-S Dental Implant 3.75D 10L	26,34
IO1042	One™ Dental Implant 4.2D 10L	50,54	ISPS1042	Touareg™-S Dental Implant 4.2D 10L	26,35
IO1050	One™ Dental Implant 5.0D 10L	50,55	ISPS1050	Touareg™-S Dental Implant 5.0D 10L	26,36
IO1130	One™ Dental Implant 3.0D 11.5L	50,51	ISPS1060	Touareg™-S Dental Implant 6.0D 10L	26,37
IO1133	One™ Dental Implant 3.3D 11.5L	50,52	ISPS1135	Touareg™-S Dental Implant 3.5D 11.5L	26,33
IO1136	One™ Dental Implant 3.6D 11.5L	50,53	ISPS1138	Touareg™-S Dental Implant 3.75D 11.5L	26,34
IO1142	One™ Dental Implant 4.2D 11.5L	50,54	ISPS1142	Touareg™-S Dental Implant 4.2D 11.5L	26,35
IO1150	One™ Dental Implant 5.0D 11.5L	50,55	ISPS1150	Touareg™-S Dental Implant 5.0D 11.5L	26,36
IO1330	One™ Dental Implant 3.0D 13L	50,51	ISPS1160	Touareg™-S Dental Implant 6.0D 11.5L	26,37
IO1333	One™ Dental Implant 3.3D 13L	50,52	ISPS1335	Touareg™-S Dental Implant 3.5D 13L	26,33
IO1336	One™ Dental Implant 3.6D 13L	50,53	ISPS1338	Touareg™-S Dental Implant 3.75D 13L	26,34
IO1342	One™ Dental Implant 4.2D 13L	50,54	ISPS1342	Touareg™-S Dental Implant 4.2D 13L	26,35
IO1350	One™ Dental Implant 5.0D 13L	50,55	ISPS1350	Touareg™-S Dental Implant 5.0D 13L	26,36
IO1530	One™ Dental Implant 3.0D 15L	50,51	ISPS1360	Touareg™-S Dental Implant 6.0D 13L	26,37
IO1533	One™ Dental Implant 3.3D 15L	50,52	ISPS1635	Touareg™-S Dental Implant 3.5D 16L	26,33
IO1536	One™ Dental Implant 3.6D 15L	50,53	ISPS1638	Touareg™-S Dental Implant 3.75D 16L	26,34
IO1542	One™ Dental Implant 4.2D 15L	50,54	ISPS1642	Touareg™-S Dental Implant 4.2D 16L	26,35
IO1550	One™ Dental Implant 5.0D 15L	50,55	ISPS1650	Touareg™-S Dental Implant 5.0D 16L	26,36
ISF0642	Touareg™-OS Dental Implant 4.2D 6.25L	26,30	ISPS1835	Touareg™-S Dental Implant 3.5D 18L	26,33
ISF0650	Touareg™-OS Dental Implant 5.0D 6.25L	26,31	ISPS1838	Touareg™-S Dental Implant 3.75D 18L	26,34
ISF0660	Touareg™-OS Dental Implant 6.0D 6.25L	26,32	ISPS1842	Touareg™-S Dental Implant 4.2D 18L	26,35
ISF0835	Touareg™-OS Dental Implant 3.5D 8L	26,28	ISPX0835	Touareg CloseFit™ RP Dental Implant 3.5D 8.0L	8,15
ISF0838	Touareg™-OS Dental Implant 3.75D 8L	26,29	ISPX0843	Touareg CloseFit™ WP Dental Implant 4.3D 8.0L	8,20
ISF0842	Touareg™-OS Dental Implant 4.2D 8L	26,30	ISPX0849	Touareg CloseFit™ WP Dental Implant 5D 8.0L	8,21
ISF0850	Touareg™-OS Dental Implant 5.0D 8L	26,31	ISPX1035	Touareg CloseFit™ RP Dental Implant 3.5D 10L	8,15
ISF0860	Touareg™-OS Dental Implant 6.0D 8L	26,32	ISPX1043	Touareg CloseFit™ WP Dental Implant 4.3D 10L	8,20
ISF1035	Touareg™-OS Dental Implant 3.5D 10L	26,28	ISPX1049	Touareg CloseFit™ WP Dental Implant 5D 10L	8,21
ISF1038	Touareg™-OS Dental Implant 3.75D 10L	26,29	ISPX1135	Touareg CloseFit™ RP Dental Implant 3.5D 11.5L	8,15
ISF1042	Touareg™-OS Dental Implant 4.2D 10L	26,30	ISPX1143	Touareg CloseFit™ WP Dental Implant 4.3D 11.5L	8,20
ISF1050	Touareg™-OS Dental Implant 5.0D 10L	26,31	ISPX1149	Touareg CloseFit™ WP Dental Implant 5D 11.5L	8,21
ISF1060	Touareg™-OS Dental Implant 6.0D 10L	26,32	ISPX1335	Touareg CloseFit™ RP Dental Implant 3.5D 13L	8,15
ISF1135	Touareg™-OS Dental Implant 3.5D 11.5L	26,28	ISPX1343	Touareg CloseFit™ WP Dental Implant 4.3D 13L	8,20
ISF1138	Touareg™-OS Dental Implant 3.75D 11.5L	26,29	ISPX1349	Touareg CloseFit™ WP Dental Implant 5D 13L	8,21
ISF1142	Touareg™-OS Dental Implant 4.2D 11.5L	26,30	ISPX1535	Touareg CloseFit™ RP Dental Implant 3.5D 15L	8,15
ISF1150	Touareg™-OS Dental Implant 5.0D 11.5L	26,31	ISPX1543	Touareg CloseFit™ WP Dental Implant 4.3D 15L	8,20
ISF1160	Touareg™-OS Dental Implant 6.0D 11.5L	26,32	ISPX1549	Touareg CloseFit™ WP Dental Implant 5D 15L	8,21
ISF1335	Touareg™-OS Dental Implant 3.5D 13L	26,28	ISPX1835	Touareg CloseFit™ RP Dental Implant 3.5D 18L	8,15
ISF1338	Touareg™-OS Dental Implant 3.75D 13L	26,29	ISPX1843	Touareg CloseFit™ WP Dental Implant 4.3D 18L	8,20
ISF1342	Touareg™-OS Dental Implant 4.2D 13L	26,30	ISPX1849	Touareg CloseFit™ WP Dental Implant 5D 18L	8,21
ISF1350	Touareg™-OS Dental Implant 5.0D 13L	26,31	NP0001	NP Abutment Screw	14
ISF1360	Touareg™-OS Dental Implant 6.0D 13L	26,32	NP0002	NP Implant Cover Screw	14
ISF1635	Touareg™-OS Dental Implant 3.5D 16L	26,28	NP0004	NP Healing Abutment 4.5mmD x 2mmL	11
ISF1638	Touareg™-OS Dental Implant 3.75D 16L	26,29	NP0005	NP 2mm Torque Driver - Long	13,56,57,63
ISF1642	Touareg™-OS Dental Implant 4.2D 16L	26,30	NP0006	NP 2mm Torque Driver - Short	13,56,57,63

Catalog No.	Description	Page No.	Catalog No.	Description	Page No.
NP0007	NP Implant Analog	14	RP0004	Star Hand Driver - Long	13,18,24,56,57,60,63
NP0008	NP Healing Abutment 4.5mmD x 3mmL	11	RP0005	Star Torque Driver - Long	13,18,24,56,57,60,63
NP0009	NP Healing Abutment 4.5mmD x 4mmL	11	RP0007	RP Implant Analog	19
NP0010	NP Straight Slim Abutment - No End Line	11	RP0010	RP Straight Abutment 3mm	16
NP0011	NP Straight Abutment 2mm	11	RP0011	RP Straight Abutment 2mm	16
NP0012	NP Healing Abutment 4.5mmD x 5mmL	11	RP0012	RP Straight Abutment 1mm	16
NP0013	NP Healing Abutment 4.5mmD x 6mmL	11	RP0013	RP Angled Abutment 15° 1mm	16
NP0014	NP Retrieval Screw for Abutments	14,60	RP0014	RP Angled Abutment 15° 2mm	16
NP0015	NP CloseFit Angled Abutment 15° 1mm	11	RP0015	RP Angled Abutment 15° 3mm	16
NP0016	NP Slim Closed Tray Transfer	14	RP0016	RP Slim Closed Tray Transfer	19
NP0017	NP Open Tray Transfer	14	RP0017	RP Open Tray Transfer	19
NP0018	NP CloseFit™ Angled Abutment 15° - No End Line	11	RP0018	Star Handpiece Driver - Short	14,19,25,56,57,60,63
NP0019	NP Straight Abutment 1mm	11	RP0019	Star Handpiece Driver - Long	14,19,25,56,57,60,63
NP0020	NP Ball Attachment 0.5mm	13	RP0020	RP Straight Slim Abutment - No End Line	16
NP0021	NP Ball Attachment 1mm	13	RP0021	RP Implant Cover Screw	19
NP0022	NP Ball Attachment 2mm	13	RP0022	RP Healing Abutment 4.5mmD x 2mmL	16
NP0023	NP Ball Attachment 3mm	13	RP0023	RP Healing Abutment 4.5mmD x 3mmL	16
NP0024	NP Ball Attachment 4mm	13	RP0024	RP Healing Abutment 4.5mmD x 4mmL	16
NP0026	NP CloseFit™ Angled Abutment 15° 2mm	11	RP0025	RP Healing Abutment 4.5mmD x 5mmL	16
NP0027	NP Closed Tray Transfer Screw	14	RP0026	RP Healing Abutment 4.5mmD x 6mmL	16
NP0028	NP Open Tray Transfer Screw	14	RP0027	RP Closed Tray Transfer Screw	19
NP0030	NP Flat Connection Abutment 2mm	12	RP0028	RP Open Tray Transfer Screw	19
NP0031	NP Flat Connection Abutment 4mm	12	RP0030	RP Flat Connection Abutment 2mm	17
NP0032	NP Straight Trans Mucosal Abutment 1mm	12	RP0031	RP Flat Connection Abutment 4mm	17
NP0033	NP Straight Trans Mucosal Abutment 2mm	12	RP0032	RP Straight Trans Mucosal Abutment 1mm	17
NP0034	NP Straight Trans Mucosal Abutment 3mm	12	RP0033	RP Straight Trans Mucosal Abutment 2mm	17
NP0035	NP Angled Trans Mucosal Abutment 17° L=3mm	12	RP0034	RP Straight Trans Mucosal Abutment 3mm	17
NP0036	NP Angled Trans Mucosal Abutment 30° L=3.5mm	12	RP0039	RP Retaining Screw For TMA 1mm	19
NP0037	NP Angled Trans Mucosal Abutment 30° L=5mm	12	RP0040	RP Retaining Screw For TMA 2mm	19
NP0038	NP Angled Trans Mucosal Abutment 17° L=4mm	12	RP0041	RP Retaining Screw For TMA 3mm	19
NP0039	NP Retaining Screw for TMA 1mm	14	RP0043	RP Engaging Temporary Abutment	16
NP0040	NP Retaining Screw for TMA 2mm	14	RP0044	RP Non-Engaging Temporary Abutment	16
NP0041	NP Retaining Screw for TMA 3mm	14	RP0045	RP Plastic Cylinder Abutment	16
NP0042	NP Retaining Screw for Angled TMA	14	RP0046	RP Slim Healing Abutment 3.5mmD x 2mmL	16
NP0043	NP Engaging Temporary Abutment	11	RP0047	RP Slim Healing Abutment 3.5mmD x 3mmL	16
NP0044	NP Non Engaging Temporary Abutment	11	RP0048	RP Slim Healing Abutment 3.5mmD x 4mmL	16
NP0045	NP Plastic Cylinder Abutment	11	RP0049	RP Slim Healing Abutment 3.5mmD x 5mmL	16
NP0046	NP Slim Healing Abutment 3mmD x 2mmL	11	RP0050	RP Slim Healing Abutment 3.5mmD x 6mmL	16
NP0047	NP Slim Healing Abutment 3mmD x 3mmL	11	RP0051	RP Ball Attachment 0.5mm	18
NP0048	NP Slim Healing Abutment 3mmD x 4mmL	11	RP0052	RP Ball Attachment 1mm	18
NP0049	NP Slim Healing Abutment 3mmD x 5mmL	11	RP0053	RP Ball Attachment 2mm	18
NP0050	NP Slim Healing Abutment 3mmD x 6mmL	11	RP0054	RP Ball Attachment 3mm	18
NP0062	NP 2mm Hex Handpiece Adapter - Short	14,56,57,63	RP0055	RP Ball Attachment 4mm	18
NP0063	NP CloseFit™ Angled Abutment 15° 3mm	11	RP0056	RP Ball Attachment 5mm	18
NP0064	NP Straight Abutment 3mm	11	RP0062	RP Handpiece Hex Adapter - Short	19,56,57,63
NP0072	NP 2mm Hex Handpiece Adapter - Long	14,56,57,63	RP0064	Star Hand Driver - Short	13,18,24,56,57,60,63
NP0090	NP Conical Healing Abutment 4.5mmD x 2mmL	11	RP0065	Star Torque Driver - Short	13,18,24,56,57,60,63
NP0091	NP Conical Healing Abutment 4.5mmD x 3mmL	11	RP0066	RP 2.2mm Torque Driver - Long	18,56,57,63
NP0092	NP Conical Healing Abutment 4.5mmD x 4mmL	11	RP0067	RP 2.2mm Torque Driver - Short	18,56,57,63
NP0093	NP Conical Healing Abutment 4.5mmD x 5mmL	11	RP0072	RP Handpiece Hex Adapter - Long	19,56,57,63
NP0094	NP Conical Healing Abutment 4.5mmD x 6mmL	11	RP0090	RP Conical Healing Abutment 4.5mmD x 2mmL	16
NP3095	NP Engaging Titanium / Plastic Abutment	12	RP0091	RP Conical Healing Abutment 4.5mmD x 3mmL	16
NP3097	NP Non-Engaging Titanium / Plastic Abutment	12	RP0092	RP Conical Healing Abutment 4.5mmD x 4mmL	16
NP3409	NP retaining Screw for TMA 4mm	14	RP0093	RP Conical Healing Abutment 4.5mmD x 5mmL	16
NP3412	NP Retaining Screw for TMA 5mm	14	RP0094	RP Conical Healing Abutment 4.5mmD x 6mmL	16
NP3729	NP Straight Trans Mucosal Abutment 4mm	12	RP3095	RP Engaging Titanium / Plastic Abutment	16
NP3730	NP Straight Trans Mucosal Abutment 5mm	12	RP3097	RP Non-Engaging Titanium / Plastic Abutment	16
PK6300	Prosthetic Kit Metal	60	RP3401	RP Retrieval Screw for Abutments	19,60
PK6303	Prosthetic Kit Tray	60	RP3403	RP Retaining Screw for Angled TMA	19
RA0040	Torque Ratchet Surgical Instruments Handle	58,59,64	RP3409	RP Retaining Screw for TMA 4mm	19
RA0050	Wrench Ratchet Surgical Instruments Handle	58,64	RP3412	RP Retaining Screw for TMA 5mm	19
RP0001	RP Abutment Screw	19	RP3729	RP Straight Trans Mucosal Abutment 4 mm	17

Catalog No.	Description	Page No.	Catalog No.	Description	Page No.
RP3730	RP Straight Trans Mucosal Abutment 5 mm	17	RS3733	RS Straight Trans Mucosal Abutment 3mm	46
RP3734	RP Angled Trans Mucosal Abutment 17° 2.5mm	17	RS3734	RS Angled Trans Mucosal Abutment 17° 2mm	46
RP3735	RP Angled Trans Mucosal Abutment 30° 3mm	17	RS3735	RS Angled Trans Mucosal Abutment 30° 3mm	46
RP3737	RP Angled Trans Mucosal Abutment 17° 3.5mm	17	RS3736	RS Angled Trans Mucosal Abutment 45° 4mm	46
RP3738	RP Angled Trans Mucosal Abutment 30° 4mm	17	RS3737	RS Angled Trans Mucosal Abutment 17° 3mm	46
RS0010	RS Straight Abutment 1mmL	45	RS3738	RS Angled Trans Mucosal Abutment 30° 4mm	46
RS0011	RS Straight Abutment 2mmL	45	RS3800	RS Straight Titanium Abutment - No End Line	44
RS0012	RS Straight Abutment 3mmL	45	RS3801	RS Straight Titanium Abutment 1mm	44
RS2650	RS Ball Attachment 0.5mm	47	RS3802	RS Straight Titanium Abutment 2mm	44
RS2651	RS Ball Attachment 1mm	47	RS3803	RS Straight Titanium Abutment 3mm	44
RS2652	RS Ball Attachment 2mm	47	RS3804	RS Straight Titanium Abutment 4mm	44
RS2653	RS Ball Attachment 3mm	47	RS3805	RS Straight Titanium Abutment 5 mm	44
RS2654	RS Ball Attachment 4mm	47	RS3811	RS Straight Titanium Abutment Long 12.5mm	44
RS2655	RS Ball Attachment 5mm	47	RS3812	RS One Piece Screw-In Abutment	45
RS2660	Plastic Ball Cap White	13,18,24,48	RS3890	RS Wide Profile Titanium Abutment	45
RS2662	Plastic Ball Cap Pink Soft	13,18,24,48	RS3903	RS Slim Titanium Abutment 3mm	44
RS2670	Titanium Ball Cap	13,18,24,48	RS3906	RS Slim Titanium Abutment 6mm	44
RS2675SS	Stainless Steel Ball Cap	13,18,24,48	RS3908	RS Slim Titanium Abutment 8mm	44
RS2861	RS Ball Attachment 1mm w/Hex	47	RS3950	Titanium Abutment 5.0 mmD Wide	44
RS2862	RS Ball Attachment 2mm w/Hex	47	RS4015	RS Angled Titanium Abutment 15°	45
RS2863	RS Ball Attachment 3mm w/Hex	47	RS4016	RS Angled Titanium Abutment 15° Long	45
RS2864	RS Ball Attachment 4mm w/Hex	47	RS4017	RS Slim Angled Abutment 15° 1mm - No End Line	45
RS2865	RS Ball Attachment 5mm w/Hex	47	RS4018	RS Slim Angled Abutment 15° 2mm - No End Line	45
RS2866	RS Ball Attachment 6mm w/Hex	47	RS4019	RS Slim Angled Abutment 15° 3mm - No End Line	45
RS3012	RS Wide Healing Abutment 6mmD x 2mmL	44	RS4025	RS Angled Titanium Abutment 25°	45
RS3013	RS Wide Healing Abutment 6mmD x 3mmL	44	RS4035	RS Angled Titanium Abutment 35°	45
RS3014	RS Wide Healing Abutment 6mmD x 4mmL	44	RS4115	RS Esthetic Angled Titanium Abutment 15° 1mm	45
RS3015	RS Wide Healing Abutment 6mmD x 5mmL	44	RS4117	RS Esthetic Angled Titanium Abutment 15° 2mm	45
RS3022	RS Healing Abutment 4.5mmD x 2mmL	44	RS4119	RS Esthetic Angled Titanium Abutment 15° 3mm	45
RS3023	RS Healing Abutment 4.5mmD x 3mmL	44	RS4900	TMA Titanium Temporary Copying	12,17,23,46
RS3024	RS Healing Abutment 4.5mmD x 4mmL	44	RS5000	RS Engaging Plastic Cylinder Casting Abutment	45
RS3025	RS Healing Abutment 4.5mmD x 5mmL	44	RS5001	TMA Plastic Casting Sleeve w/Prosthetic Screw	12,17,23,46
RS3026	RS Healing Abutment 4.5mmD x 6mmL	44	RS5004	TMA Abutment Replica	12,17,23,46
RS3027	RS Slim Healing Abutment 3.5mmD x 2mmL	44	RS5005	TMA Healing Cap	12,17,23,46
RS3028	RS Slim Healing Abutment 3.5mmD x 3mmL	44	RS5006	TMA Impression Coping Open Tray	12,17,28,47
RS3029	RS Slim Healing Abutment 3.5mmD x 4mmL	44	RS5008	TMA Screw For Open Tray Impression Copying	49
RS3030	RS Slim Healing Abutment 3.5mmD x 5mmL	44	RS5010	RS Engaging Plastic Casting Standard Abutment	45
RS3031	RS Slim Healing Abutment 3.5mmD x 6mmL	44	RS5011	TMA Closed Tray Transfer	12,17,23,47
RS3090	RS Engaging Gold / Plastic Abutment	45	RS5020	RS Non-Engaging Plastic Cylinder Casting Abutment	45
RS3095	RS Engaging Titanium / Plastic Abutment	45	RS5030	RS Engaging Plastic Standard Abutment	45
RS3097	RS Non-Engaging Titanium / Plastic Abutment	45	RS5040	RS Engaging Plastic Cylinder Abutment	45
RS3400	RS Prosthetic Screw	49	RS5050	RS Non-Engaging Plastic Standard Abutment	45
RS3401	RS Retrieval Screw For Abutments	49,60	RS5509	RS Closed Tray Transfer 9mm	49
RS3402	RS Short Prosthetic Screw	49	RS5512	RS Closed Tray Transfer 12mm	49
RS3403	RS Retaining Screw For Angled TMA	49	RS5600	RS Slim Closed Tray Transfer	49
RS3404	TMA Prosthetic Screw	49	RS5610	RS Open Tray Transfer	49
RS3406	RS Retaining Screw for TMA 1mm	49	RS5737	RS Internal Hex Implant Analog	49
RS3407	RS Retaining Screw for TMA 2mm	49	RS5740	Ball Attachment Abutment Replica	14,19,25,49
RS3408	RS Retaining Screw for TMA 3mm	49	RS6011	RS 2.4 Hex Torque Driver - Short	48,64
RS3409	RS Retaining Screw for TMA 4mm	49	RS6012	RS 2.4 Hex Torque Driver - Long	48,64
RS3411	RS Straight Cylindrical Titanium Abutment 2mm	45	RS6025	RS One Piece Torque Driver - Short	50
RS3412	RS Retaining Screw for TMA 5mm	49	RS6026	RS One Piece Torque Driver - Long	50,64
RS3422	RS Non-Engaging Straight Cylindrical Titanium Abutment 2mm	45	RS6080	1.27 Hex Torque Driver - Short	48,58,59,60,64
RS3424	RS Screw for Esthetic Connection	49	RS6082	1.27 Hex Torque Driver - Long	48,58,59,60,64
RS3425	RS Screw For Closed Tray Transfer	49	RS6090	Torque Driver for Ball Attachment	13,18,24,48,60,63,64
RS3427	RS Screw for Esthetic Connection Abutment 1.5mm	49	RS6094	1.27 Hex Hand Driver - Medium	48,58,59,60,64
RS3435	RS Implant Cover Screw	49	RS6095	1.27 Hex Hand Driver - Short	48,58,59,60,64
RS3480	RS Screw for Angled Titanium Abutment	49	RS6097	1.27 Hex Hand Driver - Long	48,64
RS3729	RS Straight Trans Mucosal Abutment 4 mm	46	RS6100	Wrench Ratchet	56,59,62
RS3730	RS Straight Trans Mucosal Abutment 5 mm	46	RS6111	Surgical Torque Ratchet 35-100 Ncm	56,57,58,59,62
RS3731	RS Straight Trans Mucosal Abutment 1mm	46	RS6112	Prosthetic Torque Ratchet 15-35 Ncm	60,62
RS3732	RS Straight Trans Mucosal Abutment 2mm	46	RS6150	Parallel Pin 11	56,57,58,59,62

Catalog No.	Description	Page No.	Catalog No.	Description	Page No.
RS6155	Parallel Pin 16	56,57,58,59,62	WP0072	WP Handpiece Hex Adapter - Long	25,56,57,63
RS6180	Depth Probe	56,57,58,59	WP0090	WP Conical Healing Abutment 5.5mmD x 2mmL	22
RS6191	TMA/FC Female Hand Hex Driver-Long	13,18,24,48,56,57,58,59,60,63,64	WP0091	WP Conical Healing Abutment 5.5mmD x 3mmL	22
RS6193	TMA/FC Female Hand Hex Driver-Short	13,18,24,48,56,57,58,59,60,63,64	WP0092	WP Conical Healing Abutment 5.5mmD x 4mmL	22
RS6194	TMA / FC Hex Handpiece Adapter - Short	14,19,25,48,60,63,64	WP0093	WP Conical Healing Abutment 5.5mmD x 5mmL	22
RS6195	RS Small Metal Surgical Kit	14,19,25,48,60	WP0094	WP Conical Healing Abutment 5.5mmD x 6mmL	22
RS6195A	TMA / FC Hex Handpiece Adapter - Long	14,19,25,48,60,63,64	WP3095	WP Engaging Titanium / Plastic Abutment	22
RS6196	TMA / FC Hex Torque Driver - Long	13,18,24,48,60,63,64	WP3097	WP Non-Engaging Titanium / Plastic Abutment	22
RS6197	TMA / FC Hex Torque Driver - Short	13,18,24,48,60,63,64	WP3401	WP Retrieval Screw for Abutments	25,60
RS6301	RS - Standard Internal Hex Plastic Surgical Kit - Premium	58	WP3403	WP Retaining Screw for Angled TMA	25
RS6322	RS - Standard Internal Hex Plastic Surgical Kit - Advanced	58	WP3406	WP Retaining Screw for TMA 1mm	25
RS6333	RS - Standard Internal Hex Plastic Surgical Kit - Starter	58	WP3407	WP Retaining Screw for TMA 2mm	25
RS7001	Surgical Driver	62	WP3408	WP Retaining Screw for TMA 3mm	25
RS8032	Tip Drill	56,57,58,59,61	WP3409	WP Retaining Screw for TMA 4mm	25
RS9020	RS Hex Handpiece Adapter - Short	48,64	WP3412	WP Retaining Screw for TMA 5mm	25
RS9021	RS Hex Handpiece Adapter - Short	58,59,64	WP3729	WP Straight Trans Mucosal Abutment 4mm	23
RS9025	RS Hex Handpiece Adapter - Long	48,64	WP3730	WP Straight Trans Mucosal Abutment 5mm	23
RS9026	RS Hex Handpiece Adapter - Medium	58,59,64	WP3731	WP Straight Trans Mucosal Abutment 1mm	23
RS9027	Drill Extension	56,57,58,59,61	WP3732	WP Straight Trans Mucosal Abutment 2mm	23
RS9029	RS Hex Handpiece Adapter - Long	58,59,64	WP3733	WP Straight Trans Mucosal Abutment 3mm	23
RS9030	1.27 Hex Driver for Handpiece - Short	48,60,63	WP3734	WP Angled Trans Mucosal Abutment 17° 2.5mm	23
RS9035	1.27 Hex Driver for Handpiece - Long	48,60,64	WP3735	WP Angled Trans Mucosal Abutment 30° 3mm	23
TD1511	Three Step Drill - Short	56,57,58,61	WP3737	WP Angled Trans Mucosal Abutment 17° 3.5mm	23
TD2218	Three Step Drill - Long	56,57,58,59,61	WP3738	WP Angled Trans Mucosal Abutment 30° 4mm	23
WP0001	WP Abutment Screw	25	ZA0005	RS Straight Zirconium Abutment w/ Titanium Base	46
WP0007	WP Implant Analog	25	ZA0007	RS Angled Zirconium Abutment 15° w/ Titanium Base	46
WP0010	WP Straight Abutment 3mm	22	ZA0101	NP Screw For Zirconia Abutment	14
WP0011	WP Straight Abutment 2mm	22	ZA0105	NP Straight Zirconium Abutment w/ Titanium Base	12
WP0012	WP Straight Abutment 1mm	22	ZA0107	NP Angled Zirconium Abutment 15° w/ Titanium Base	12
WP0013	WP Angled Abutment 15° 1mm	22	ZA0201	RP Screw For Zirconia Abutment	19
WP0014	WP Angled Abutment 15° 2mm	22	ZA0207	RP Angled Zirconium Abutment 15° w/ Titanium Base	17
WP0015	WP Angled Abutment 15° 3mm	22	ZA0214	RP Straight Zirconium Abutment w/ Titanium Base	17
WP0016	WP Slim Closed Tray Transfer	25	ZA0301	WP Screw for Zirconia Abutment	25
WP0017	WP Open Tray Transfer	25	ZA0307	WP Angled Zirconium Abutment 15° w/ Titanium Base	23
WP0020	WP Straight Slim Abutment - No End Line	22	ZA0314	WP Straight Zirconium Abutment w/ Titanium Base	23
WP0021	WP Implant Cover Screw	25	ZA1005	RS Straight Zirconium Abutment w/ Titanium Base 1mm	46
WP0022	WP Healing Abutment 5.5mmD x 2mmL	22	ZA1006	RS Straight Zirconium Abutment w/ Titanium Base 2mm	46
WP0023	WP Healing Abutment 5.5mmD x 3mmL	22	ZA1007	RS Straight Zirconium Abutment w/ Titanium Base 3mm	46
WP0024	WP Healing Abutment 5.5mmD x 4mmL	22	ZA1008	RS Straight Zirconium Abutment w/ Titanium Base 4mm	46
WP0025	WP Healing Abutment 5.5mmD x 5mmL	22	ZA1009	RS Straight Zirconium Abutment w/ Titanium Base 5mm	46
WP0026	WP Healing Abutment 5.5mmD x 6mmL	22	ZA1015	RS Angled Zirconium Abutment w/ Titanium Base 1mm	46
WP0027	WP Closed Tray Transfer Screw	25	ZA1016	RS Angled Zirconium Abutment w/ Titanium Base 2mm	46
WP0028	WP Open Tray Transfer Screw	25	ZA1017	RS Angled Zirconium Abutment w/ Titanium Base 3mm	46
WP0030	WP Flat Connection Abutment 2mm	23	ZA1018	RS Angled Zirconium Abutment w/ Titanium Base 4mm	46
WP0031	WP Flat Connection Abutment 4mm	23	ZA1019	RS Angled Zirconium Abutment w/ Titanium Base 5mm	46
WP0043	WP Engaging Temporary Abutment	22			
WP0044	WP Non-Engaging Temporary Abutment	22			
WP0045	WP Plastic Cylinder Abutment	22			
WP0046	WP Slim Healing Abutment 4mmD x 2mmL	22			
WP0047	WP Slim Healing Abutment 4mmD x 3mmL	22			
WP0048	WP Slim Healing Abutment 4mmD x 4mmL	22			
WP0049	WP Slim Healing Abutment 4mmD x 5mmL	22			
WP0050	WP Slim Healing Abutment 4mmD x 6mmL	22			
WP0051	WP Ball Attachment 0.5mm	24			
WP0052	WP Ball Attachment 1mm	24			
WP0053	WP Ball Attachment 2mm	24			
WP0054	WP Ball Attachment 3mm	24			
WP0055	WP Ball Attachment 4mm	24			
WP0056	WP Ball Attachment 5mm	24			
WP0062	WP Handpiece Hex Adapter - Short	25,56,57,63			
WP0066	WP 2.6mm Torque Driver - Long	24,56,57,63			
WP0067	WP 2.6mm Torque Driver - Short	24,56,57,63			

ADIN products meet and exceed the highest standards set by the FDA and other regulatory agencies. All ADIN products are CE-marked in accordance with the Council Directive 93/42/EEC and Amendment 2007/47/EC. ADIN complies with ISO13485:2012 and the Canadian Medical Devices Conformity Assessment System (CMDCAS). Product availability may vary between countries. For more information, please contact your local ADIN office.



LEAVE  
LIMITS  
BEHIND



Leading You  
to Success







[www.adin-implants.com](http://www.adin-implants.com)



Industrial Park Allon Tavor, POB 1128, Afula 1811101, Israel  
T. +972-4-6426732 | F. +972-4-6426733 | [info@adin-implants.com](mailto:info@adin-implants.com)